



[www.nortalu.pt](http://www.nortalu.pt)

**SÉRIE STANDARD**



# SÉRIE STANDARD



## SÉRIE STANDARD

Os perfis standard são utilizados como complemento aos sistemas de caixilaria. Existindo uma variedade de soluções como cantoneiras, tubos, lâminas solares e revestimento, divisórias, vitrines, carroçarias, estores, redes mosquiteiras, mobiliários e armários.

### Soluções Construtivas:

- Tubos;
- Cantoneiras;
- Lâminas Solares;
- Divisórias;
- Estores;
- Vitrines;
- Carroçarias;
- Redes Mosquiteiras;
- Mobiliário;
- Armários.

### Vedantes:

- Material em EPDM ou PVC em conformidade com a norma aplicável.

### Acessórios:

- Materiais em alumínio, zamac, aço inox e nylon em conformidade com a norma aplicável.



[www.nortalu.pt](http://www.nortalu.pt)

Referência	A	B
R.19	9	1
R.20	10	1
R.01	10	2
R.02	12	1
R.41	12	1.5
R.21	12	4
R.03	13	1.5
R.44	15	1.5
R.04	16	1
R.45	16	1.5
R.05	18	1
R.22	18	1.3
R.06	19	1
R.46	19	1.5
R.47	20	1.7
R.07	20	5.4
R.08	22	1.6
R.09	22	2
R.23	25	1.2
R.10	25	1.5
R.11	25	3
R.24	25	4.5
R.48	28	1.5
R.25	28	5
R.49	30	1.5
R.12	30	3
R.26	30	5.75
R.27	30	7
R.28	32	1.5
R.29	35	1.2
R.13	35	2.5
R.14	35	3
R.30	35	11.25
R.50	40	1.5

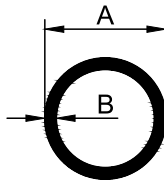

*Tubo Redondo*

Referência	A	B
R.43	40	2
R.31	40	5.5
R.15	40	6.75
R.51	45	1.5
R.16	45	3
R.32	46	5
R.33	46	6.75
R.34	46	7.5
R.17	50	1.5
R.52	50	3
R.35	52	8.25
R.36	52	9.25
R.37	54	2
R.53	57	2
R.38	58	9
R.18	60	1.5
R.54	60	3.5
R.39	60	5
R.55	63.5	1.5
R.56	68	2.5
R.57	70	1.5
R.42	75	1.7
R.58	75	2.5
R.59	80	1.5
R.40	80	5
R.60	90	2
R.61	90	3.75
R.62	95	2.5
R.63	100	2
R.64	110	2.5
R.65	114	4.5
R.66	120	10
R.67	125	2.3
R.68	127	2

# SÉRIE STANDARD

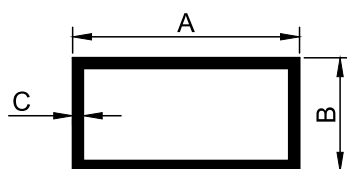

*Tubos Rectangulares*

Referência	A	B	C
P.01	20	15	2
P.01A	25	15	2
P.02	30	15	1.4
P.50	30	20	2
P.03	35	15	1.1
P.44	35	25	2
P.29	40	20	1.3
P.04	40	20	1.4
P.05	40	20	2
P.06	40	20	2.5
P.34	45	25	1.5
P.35	50	25	1.5
P.07	50	25	2
P.36	50	30	1.5
P.08	50	30	1.8
P.30	50	30	5
P.51	60	15	1.5
P.25	60	20	1.3
P.33	60	30	2
P.37	60	40	1.3
P.09	60	40	2
P.10	65	30	1.5
P.47	65	30	3
P.38	65	50	3
P.11	70	20	1.2
P.23	70	20	1.6
P.39	70	25	1.6
P.54	70	35	1.6
P.12	70	40	1.5

Referência	A	B	C
P.13	70	40	2
P.15	75	40	1.5
P.55	75	40	2
P.26	80	20	1.2
P.56	80	20	1.5
P.57	80	30	1.5
P.16	80	40	1.5
P.52	80	40	2
P.32	80	50	3
P.53	85	30	1.5
P.17	85	30	1.8
P.49	100	20	1.5
P.18	100	40	1.5
P.43	100	40	2
P.19	100	45	1.5
P.45	100	50	2
P.42	100	50	4
P.58	120	40	1.7
P.20	120	40	2.5
P.59	125	15	2
P.21	125	85	2
P.60	140	70	2.5
P.27	150	25	2.4
P.61	150	50	1.8
P.46	150	50	2.5
P.62	150	60	2.2
P.22	150	90	2.5
P.28	165	125	3.5
P.41	200	50	3



Referência	A	B
Q.27	12	1
Q.26	15	1
Q.01	19	1
Q.28	19	1.4
Q.02	20	1.5
Q.22	20	2
Q.29	25	1.5
Q.03	25	2
Q.30	30	1.5
Q.04	30	1.8
Q.05	35	1.5
Q.06	40	1.5
Q.25	40	2
Q.31	45	2
Q.07	50	1.5
Q.20	60	1.5
Q.08	60	2
Q.23	60	3
Q.18	60	4
Q.19	65	1.2
Q.09	65	1.4
Q.32	65	2
Q.10	70	2
Q.11	75	1.5
Q.33	75	2
Q.34	80	1.5
Q.24	80	2
Q.12	85	1.5
Q.13	85	2
Q.14	90	1.8
Q.16	100	2
Q.15	105	2
Q.35	130	2.7
Q.17	150	2.5
Q.21	150	4

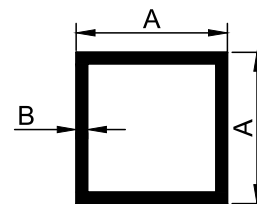

*Tubos Quadrados*

# SÉRIE STANDARD

Referência	A	B	C	D
T.01	12	12	1.8	1.8
T.02	20	20	2	2
T.06	25	25	2	2
T.04	25	25	2.5	2.5
T.05	25	42	2	2
T.03	25	45	2	2
T.07	26	14	2	2
T.08	28	50	1.5	1.5
T.09	30	30	2	2
T.10	30	40	1.5	1.5

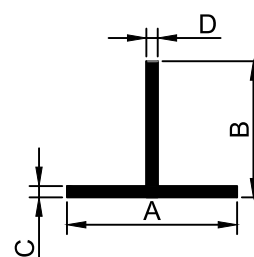

*Perfil em T*

Referência	A	B
L.01	12	1.5
L.02	15	1.1
L.03	15	1.5
L.04	20	1.5
L.05	20	2
L.20	20	3
L.06	25	1.5
L.07	30	1.5
L.50	30	3
L.21	35	2
L.18	40	1.4
L.08	40	1.5
L.09	40	2.5
L.10	40	5
L.11	43	1.5
L.12	50	2
L.13	50	3
L.47	50	4.8
L.19	50	5
L.14	60	5
L.15	70	6.7
L.22	80	5
L.16	80	8

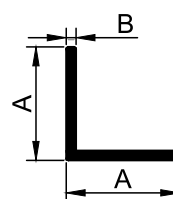

*Cantoneira Abas Iguais*

Referência	A	B	C
L.48	20	8	2
L.52	20	10	2
L.46	20	12	1.6
L.53	25	12	2
L.43	30	15	1.5
L.30	32	5.6	1.8
L.51	32	17	1.8
L.54	35	20	1.5
L.55	35	25	1.8
L.45	40	20	1.5
L.31	40	20	2
L.49	40	30	2
L.56	50	20	1.5
L.32	50	30	5
L.57	52	17	2
L.44	60	15	2
L.33	60	20	2
L.36	60	30	1.9
L.37	60	40	2
L.58	62	17	2
L.59	75	20	2
L.38	80	20	2
L.39	80	30	1.9
L.40	80	40	2
L.34	100	20	2
L.60	100	30	1.9
L.41	100	50	3
L.42	100	60	5.9
L.61	110	40	2
L.62	110	50	4.8
L.63	125	76	6.5
L.35	180	80	8

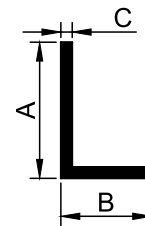

*Cantoneira Abas Desiguais*

# SÉRIE STANDARD

Referência	A	B	C	D
U.11	9	10	1.5	1.5
U.12	10	10	1.3	1.3
U.13	11	11	1.3	1.3
U.20	13	15	1.5	1.5
U.24	13	25	1.5	1.5
U.14	14.2	20	1.1	1.1
U.21	15	15	1.5	1.5
U.10	15	20	1	1
U.25	15	25	1.5	1.5
U.03	17	17	2	2
U.32	18	9	2	2
U.28	18	11	2	2
U.08	18	15	1.5	1.5
U.29	18	20	1	1
U.26	18	25	1.5	1.5
U.05	18.6	21	1.8	1.8
U.15	20	10	2	2
U.01	20	18	1.8	1.8
U.22	20	20	1.5	1.5
U.33	22	9	2	2
U.30	22.4	20	1.5	1.5
U.23	23	15	1.5	1.5
U.27	23	25	1.5	1.5
U.09	25	20	1.5	1.5
U.16	25	25	2	2
U.34	26	9	2	2
U.31	26	20	1.5	1.5
U.02	30	18.5	1.5	1.5
U.17	30	20	2	2
U.18	30	30	2	2
U.19	33.5	17.5	1.5	1.5
U.35	34.5	32	2	2
U.36	38	14	1.25	1.25
U.37	38.5	16.5	1.5	1.5
U.38	40	20	2	2
U.07	40	35	3	3
U.04	43	40	1.2	1.2
U.06	45	32	2	2
U.39	50	25	2.5	2.5
U.40	50	36	2	2
U.41	60	12.5	1.5	1.5
U.42	60	40	4	4
U.43	80	40	4	4
U.44	80	50	5	5
U.45	100	50	4.8	4.8

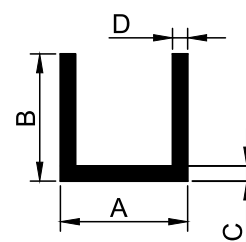

Perfil U

Referência	A	B
B.36	7.5	6
B.28	9.5	1.5
B.01	10	3
B.37	10	5
B.38	12	4
B.39	12	6
B.29	13	3
B.40	13	5
B.41	14	10
B.42	15	3
B.43	15	5
B.45	15	10
B.02	18	3
B.04	20	3
B.03	20	4
B.46	20	5
B.47	20	8
B.05	24	3
B.06	25	3
B.24	25	5
B.07	25	8
B.08	28	10
B.09	30	2
B.10	30	3
B.48	30	5
B.49	30	8
B.11	30	10
B.12	30	16
B.35	34	5
B.13	35	5.8
B.50	35	20
B.51	35	28
B.14	36	3
B.52	37.1	10.9
B.25	39.9	34.9
B.33	40	3
B.32	40	4
B.53	40	8
B.30	40	10

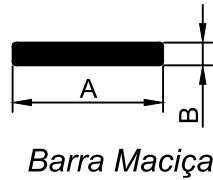

Referência	A	B
B.54	45	3
B.34	45	5
B.55	50	1.5
B.15	50	2.5
B.56	50	5
B.57	50	8
B.16	50	10
B.58	57	6
B.27	60	3
B.59	60	4
B.60	60	8
B.61	60	10
B.17	60	15
B.62	60	25
B.63	63	12
B.64	65	6
B.65	65.2	3
B.66	70	5
B.18	70	10
B.67	70	25
B.68	75	10
B.69	77	31.8
B.70	77	38.5
B.71	77	45
B.72	80	5
B.19	80	8
B.20	80	10
B.73	80	20
B.21	95	5
B.74	100	4
B.75	100	5
B.22	100	8
B.76	100	10
B.77	100	20
B.26	105	30
B.78	120	10
B.23	150	10
B.79	150	15
B.31	200	10
B.80	200	20



# SÉRIE STANDARD

Referência	A
G.04	4
G.05	5
G.06	6
G.07	7
G.08	8
G.09	9
G.10	10
G.11	11
G.12	12
G.14	14
G.16	16
G.18	18
G.19	19
G.20	20
G.22	22
G.25	25
G.28	28
G.30	30
G.32	32
G.35	35
G.37	37.5
G.38	38
G.40	40
G.45	45
G.50	50
G.52	52.5
G.60	60
G.62	62

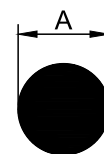

*Redondo Maciço*

Referência	A
QM.08	8
QM.10	10
QM.12	12
QM.15	15
QM.16	16
QM.20	19.9
QM.25	25
QM.30	30

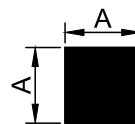

*Quadrado Maciço*

**ST.73** *Tube Rectangular 92\*30\*1.4mm*

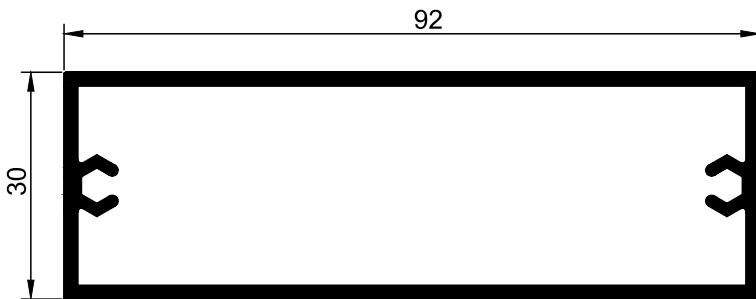

**ST.72** *Tube Rectangular 50\*30\*1.4mm*



**P.40** *Tube Rectangular 150\*25\*2.5mm*

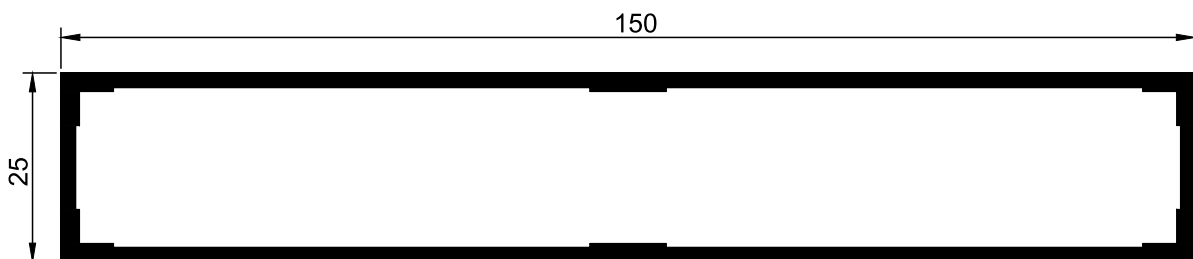

**P.14** *Tube Rectangular 100\*20\*1mm*

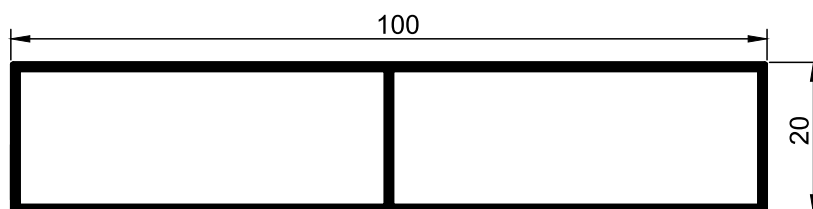

**P.31** *Tube Rectangular 170\*15\*1.45mm*

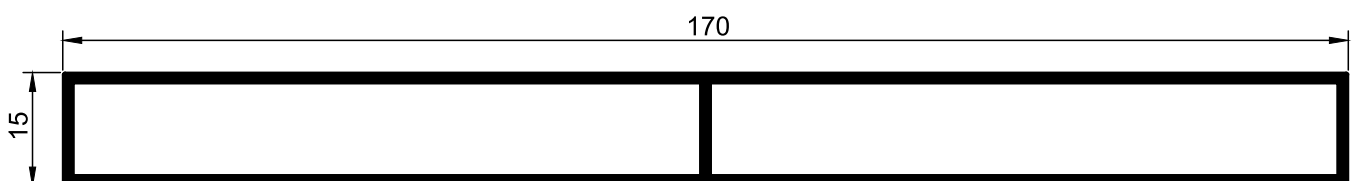

# SÉRIE STANDARD

**DI.11** *Capa Divisória*

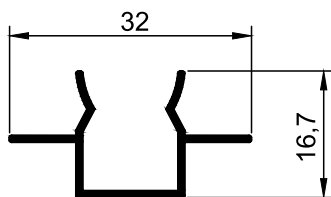

**DI.07** *Capa Divisória*

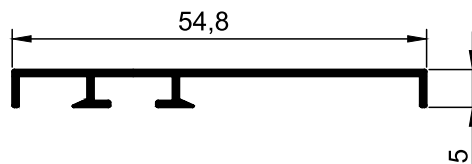

**DI.06** *Capa Dupla Divisória*

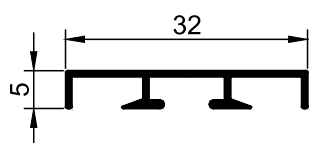

**DI.04** *Capa Divisória*

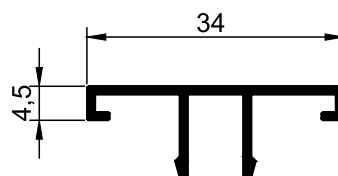

**DI.02** *Capa Divisória*

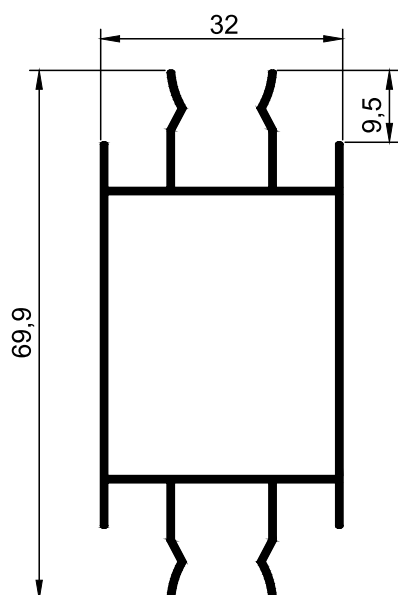

**DI.03** *Montante/Travessa*

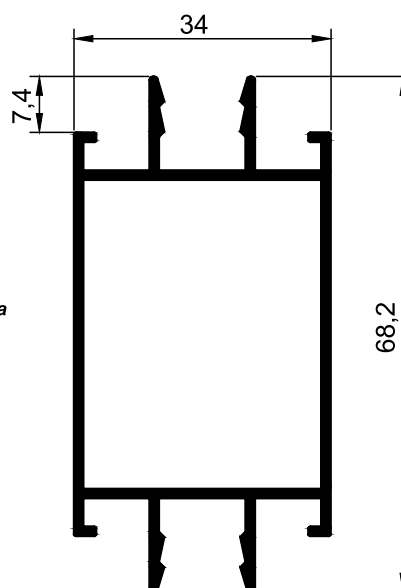

**DI.01** *Montante/Travessa*

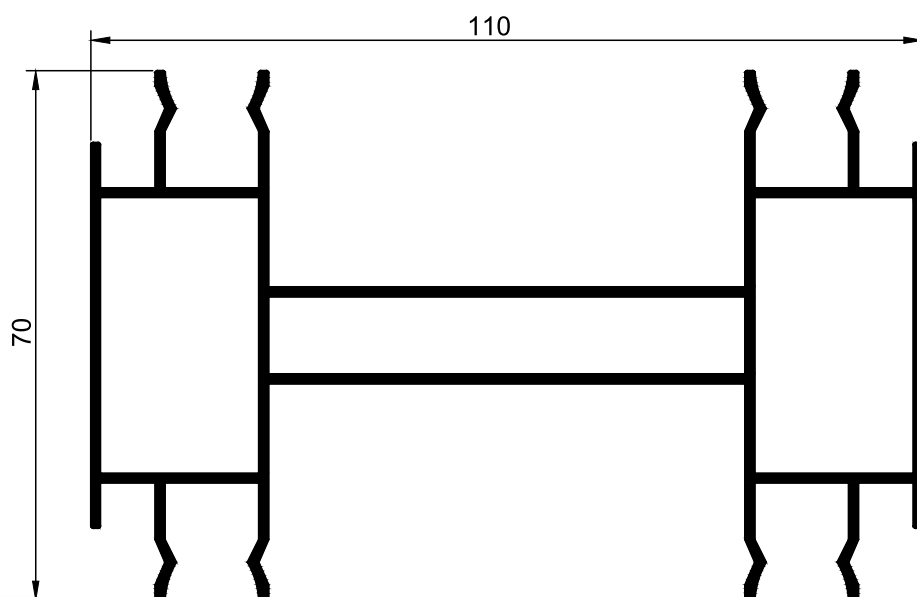

**DI.05** *Montante/Travessa Dupla*

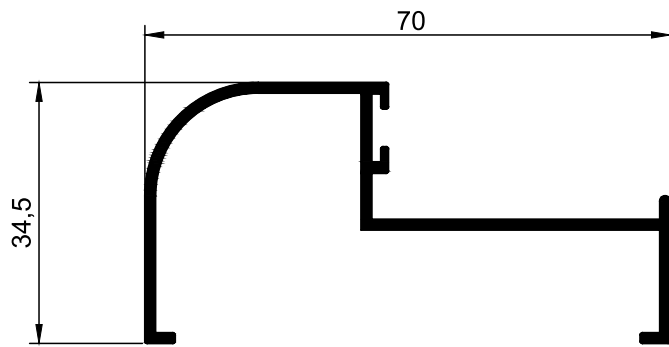

**DI.12** *Aro Porta*

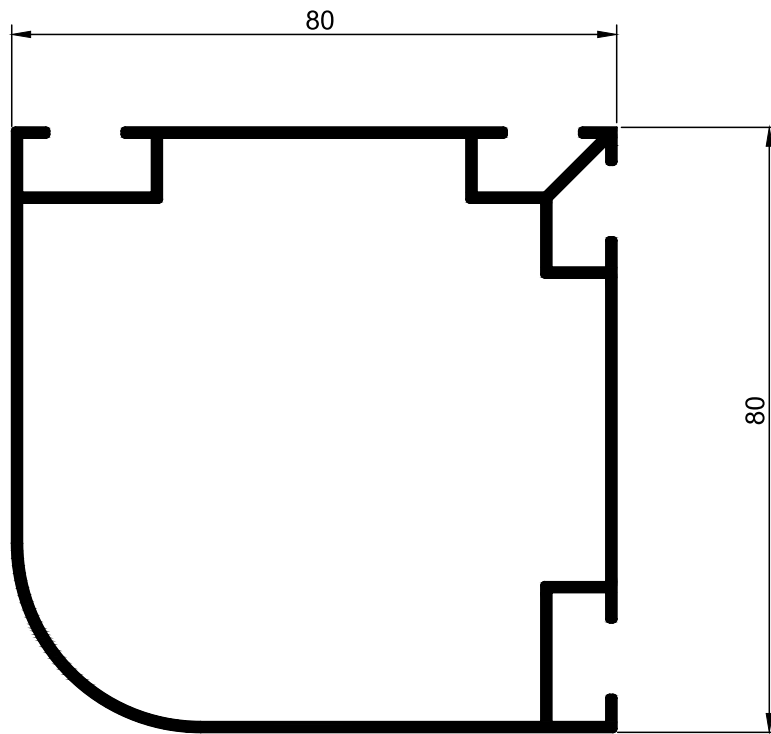

**DI.09** *Montante Duplo*

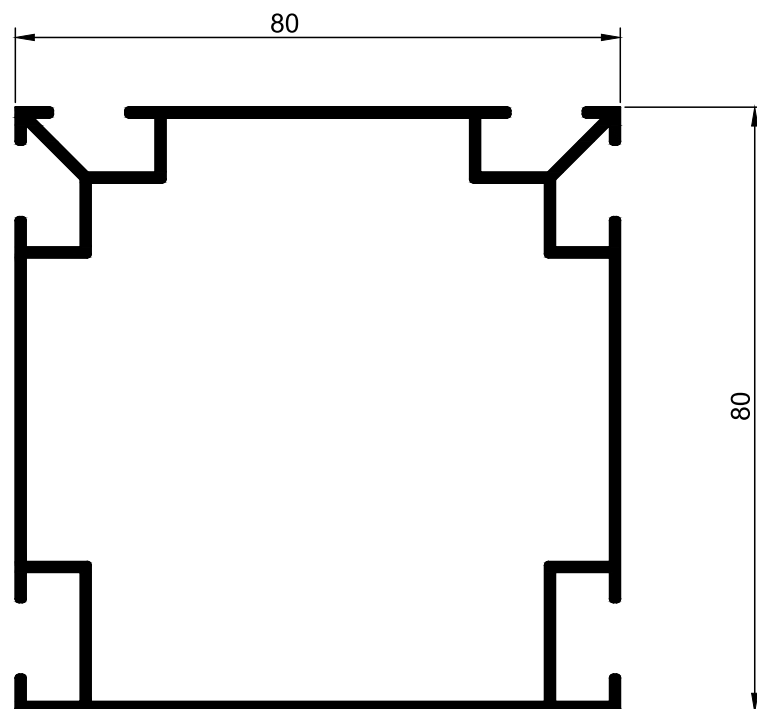

**DI.10** *Montante Triplo*

# SÉRIE STANDARD

**LS.01** *Lâmina Solar 120mm*

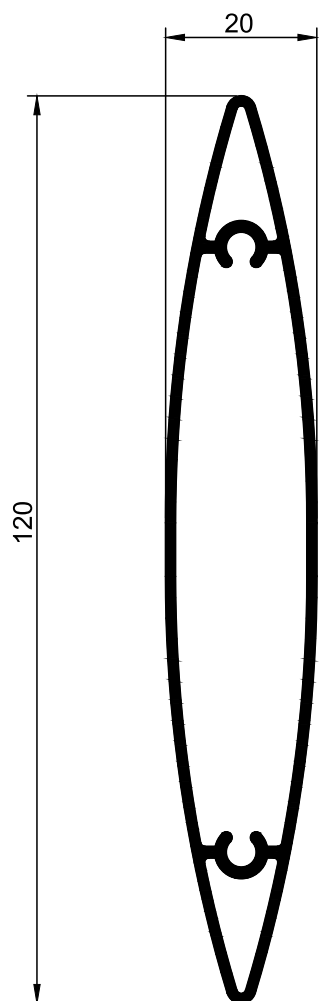

**LS.06** *Lâmina Solar 150mm*

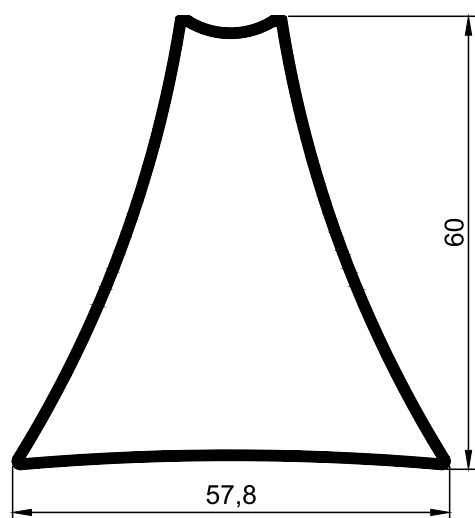
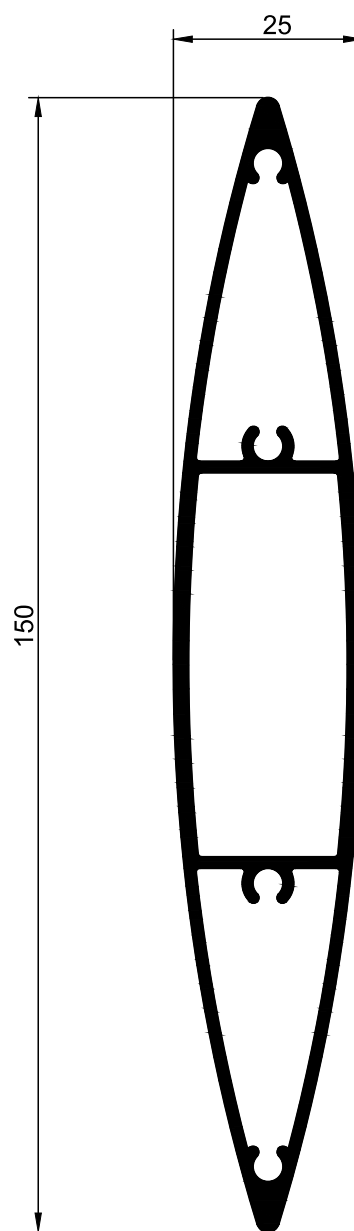

**ST.78** *Lâmina Triângular*



**LS.02** *Lâmina Solar 170mm*

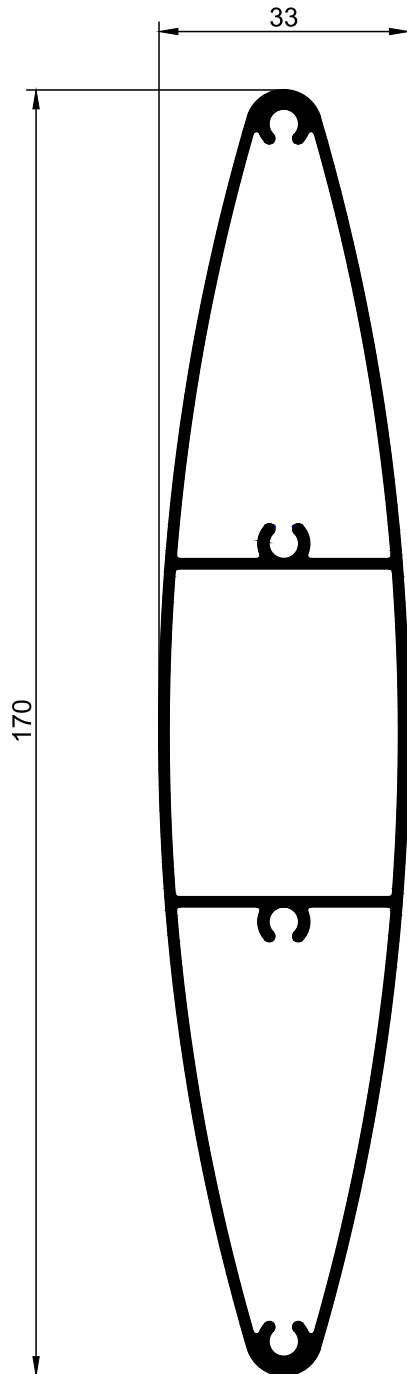

**LS.03** *Lâmina Solar 200mm*

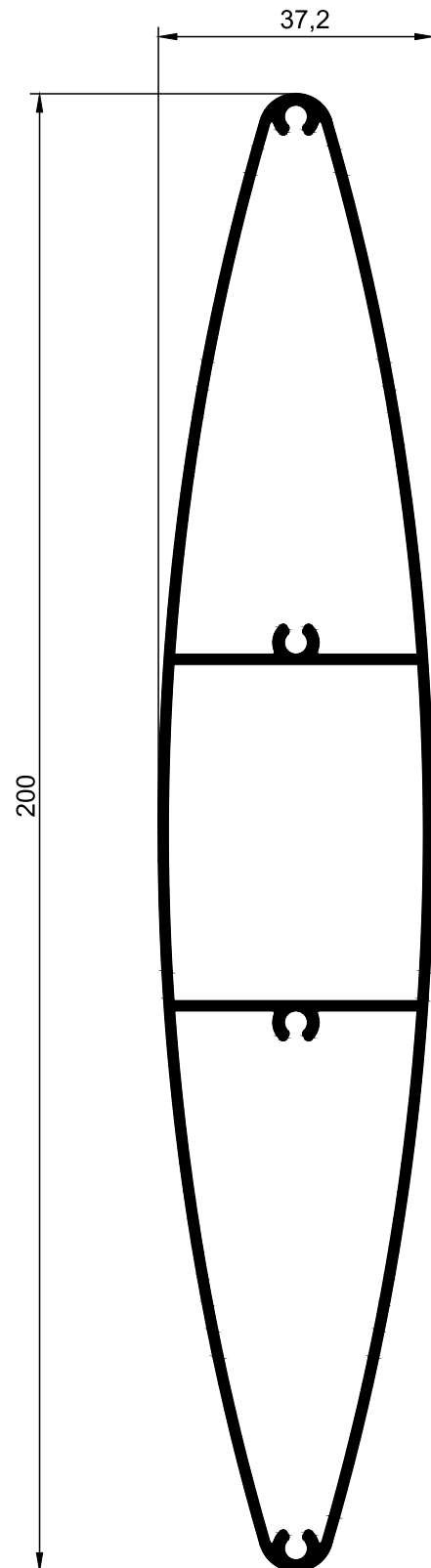

# SÉRIE STANDARD

LS.05 *Lâmina Solar 300mm*

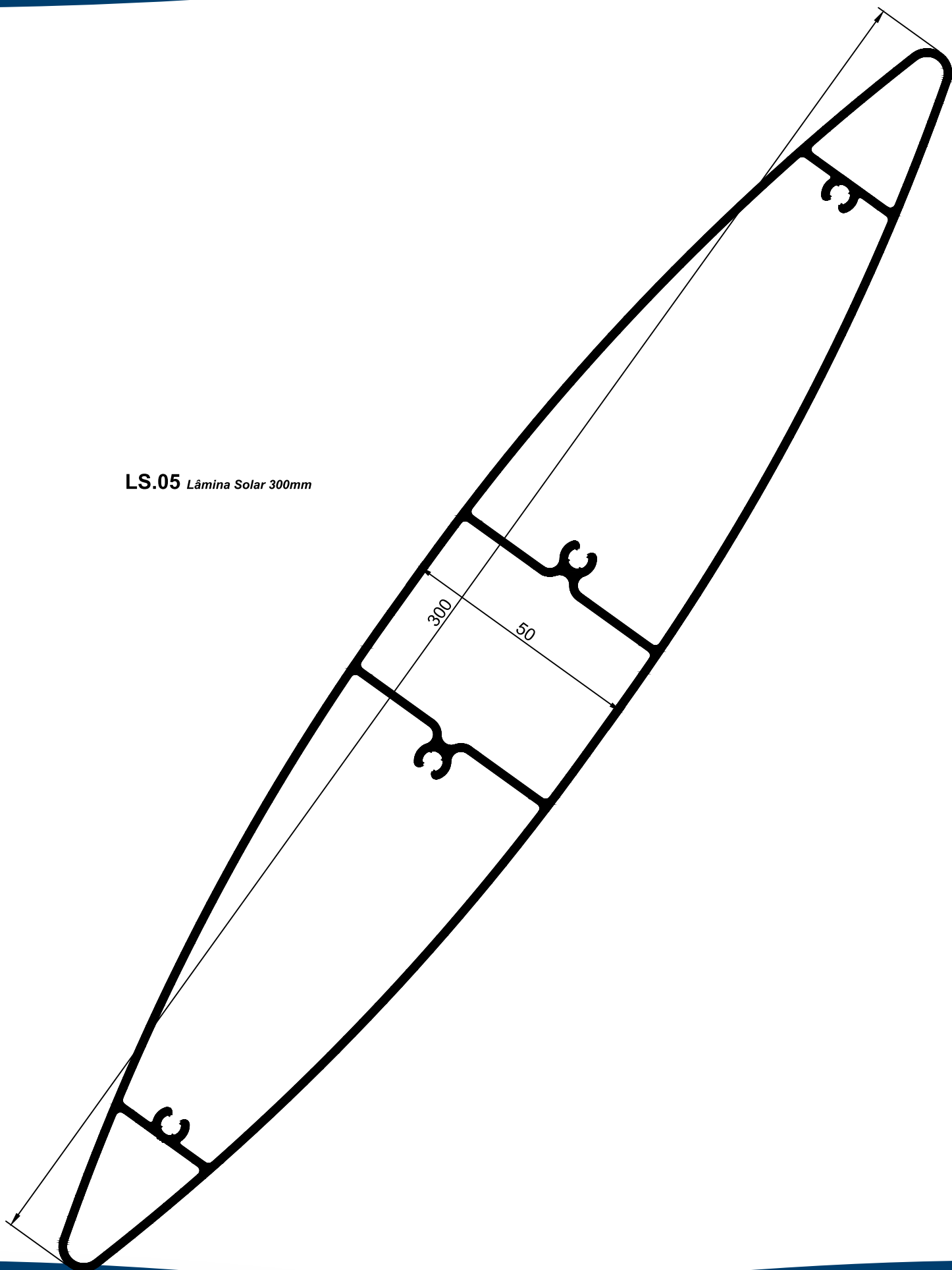

LS.08 *Lâmina Solar 400mm*

LS.07 *Lâmina Solar 350mm*

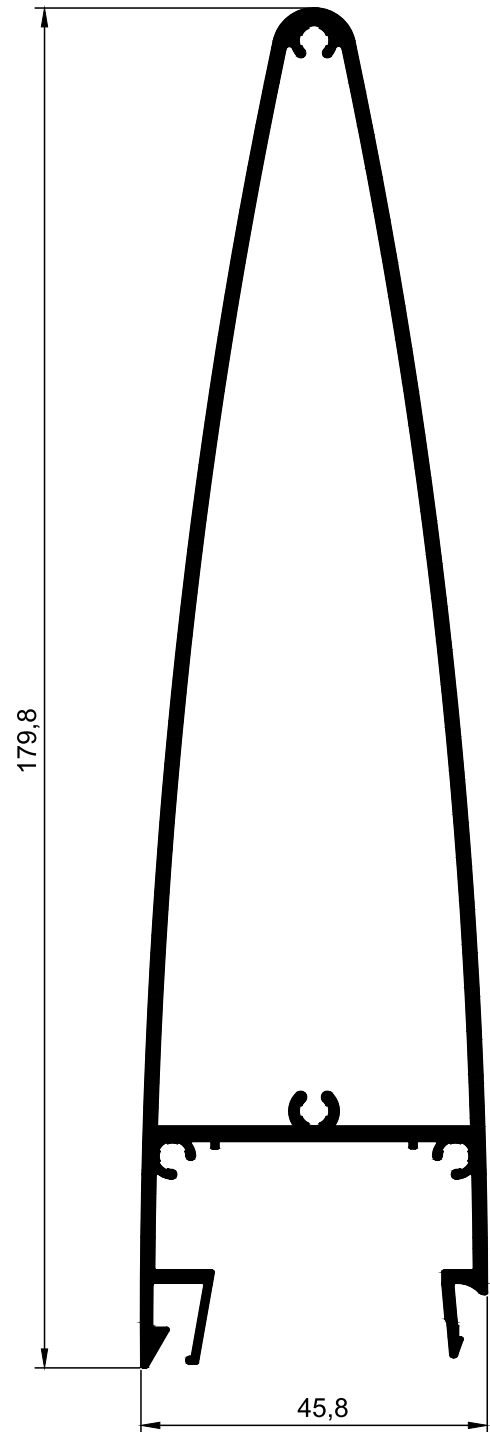
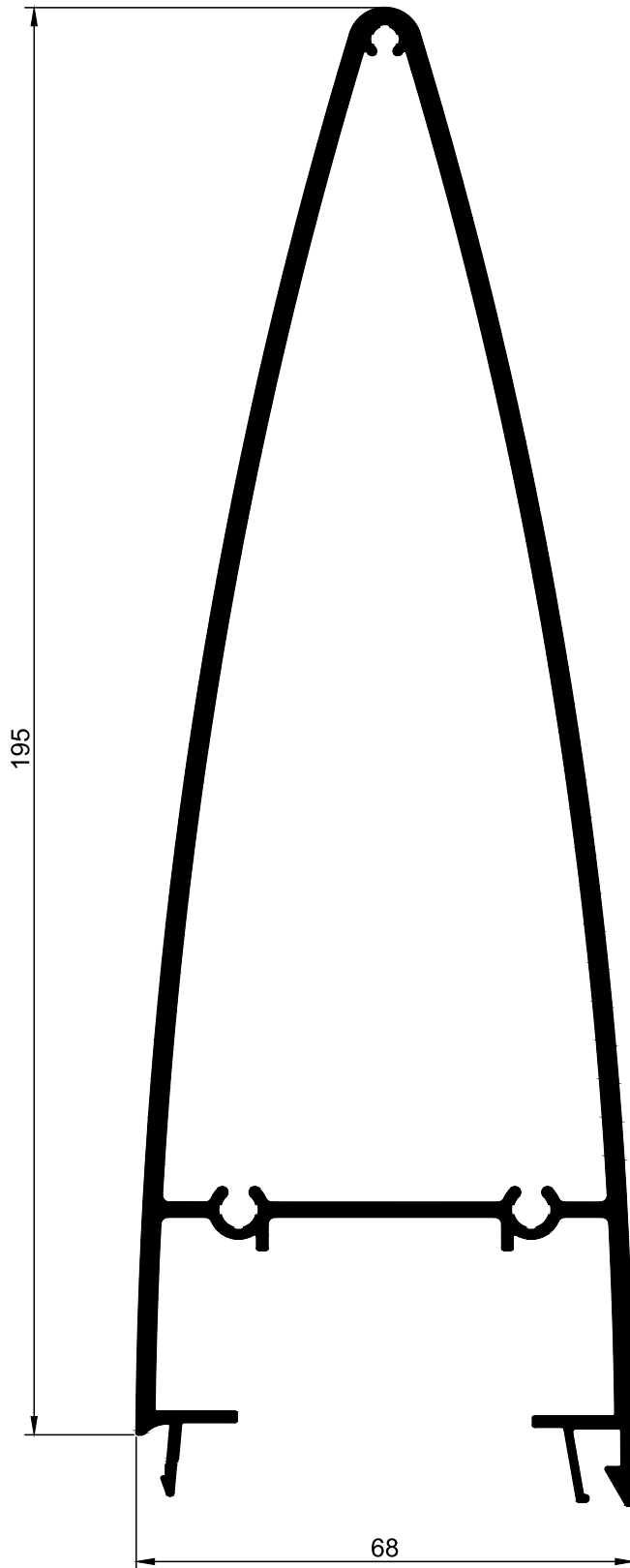

LS.37 *Lâmina Solar 150mm*

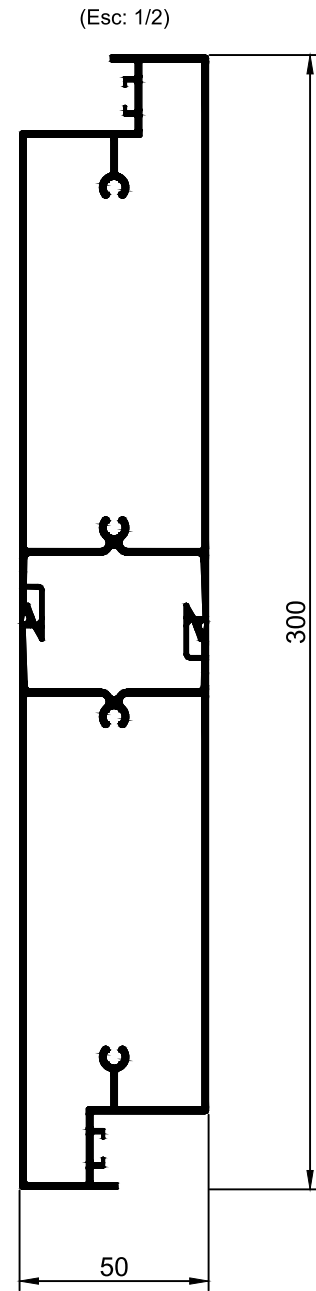
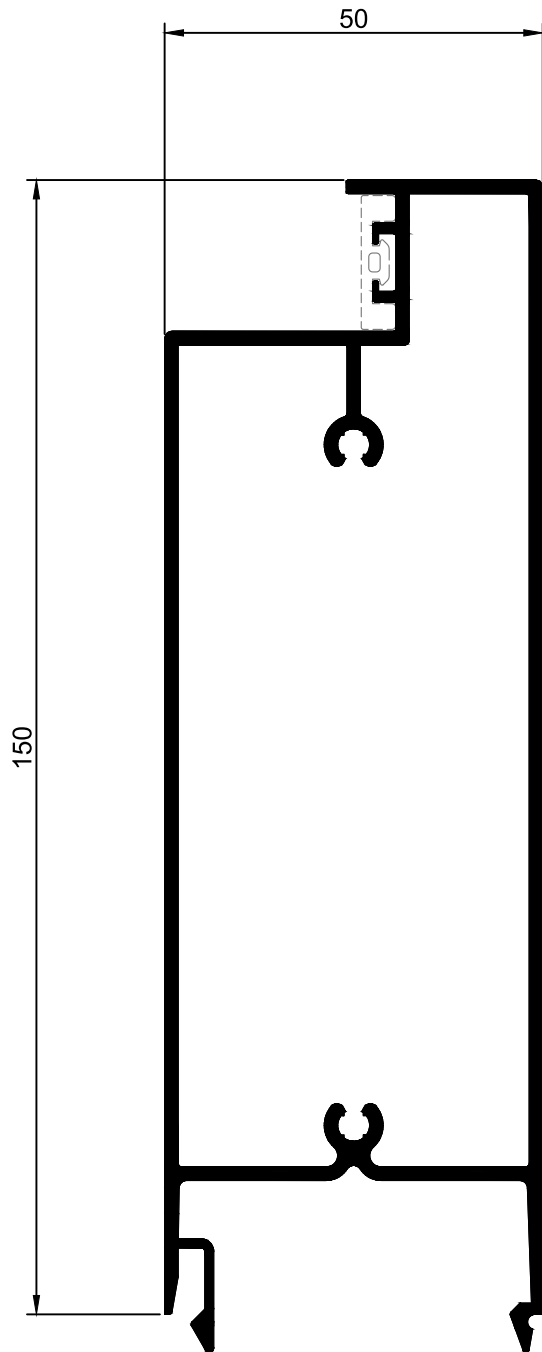

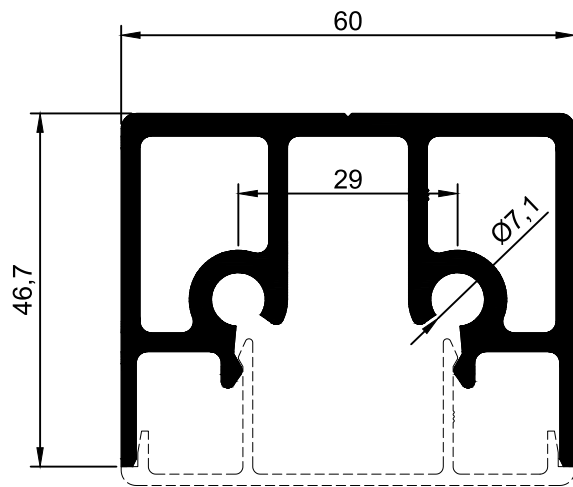

**PT.208** *Perfil Decorativo*

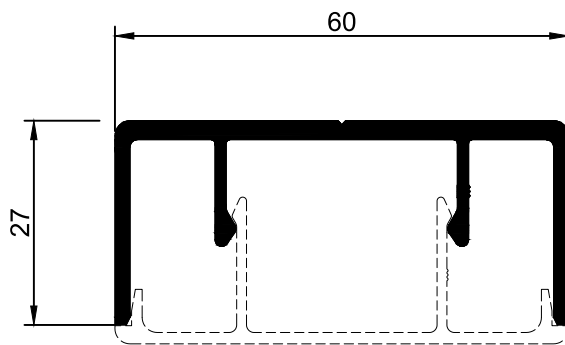

**PT.209** *Perfil Decorativo*

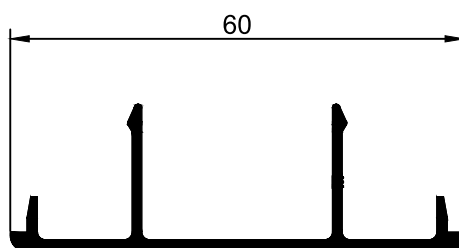

**PT.210** *Perfil Decorativo Capa*



**LS.13** *Fixador Lâmina*

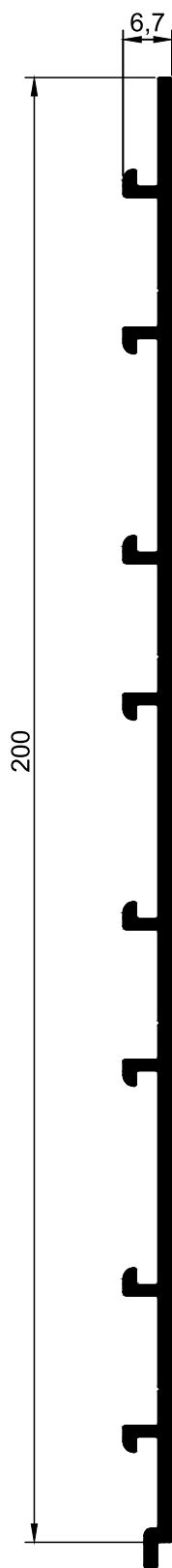

**LS.11** *Lâmina 45\*65mm*

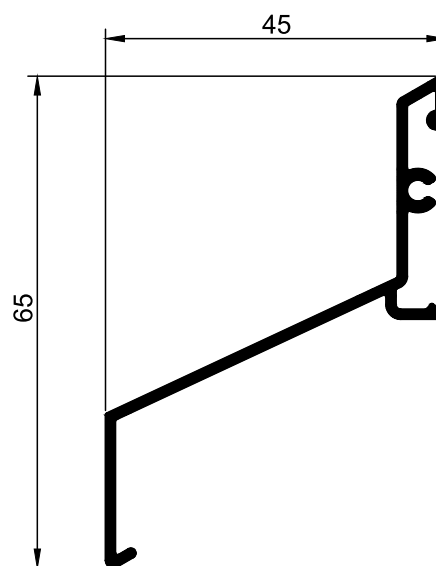

**LS.12** *Lâmina 45\*80mm*

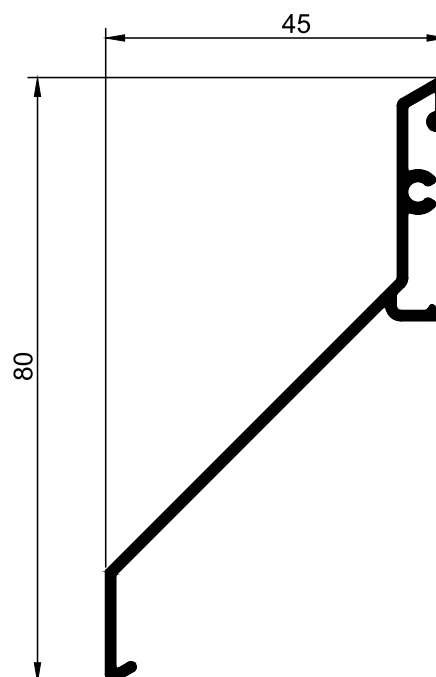

**LS.34** Lâmina 20.4\*38.4mm

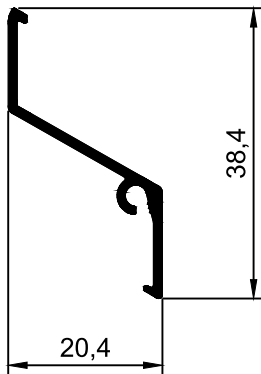

**LS.32** Lâmina 46\*90mm

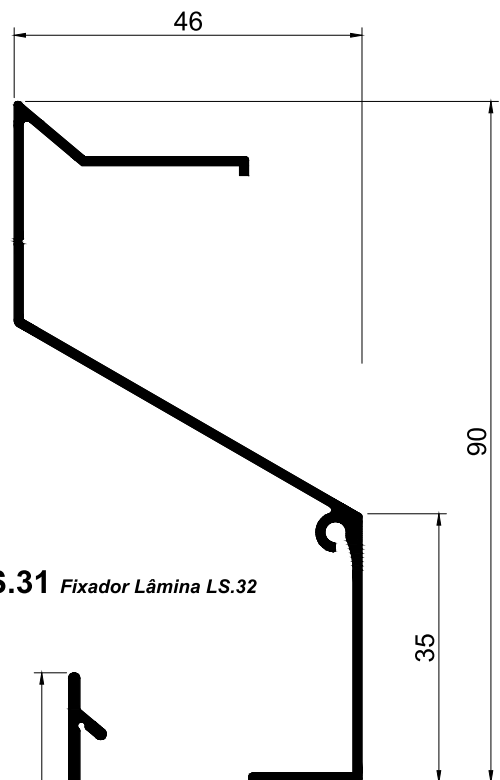

**LS.33** Fixador Lâmina LS.34

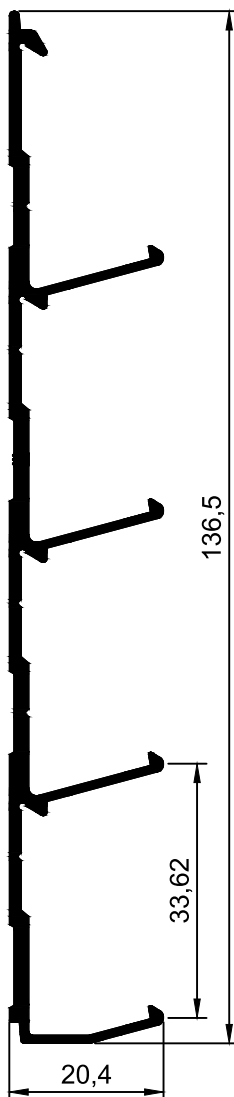

**LS.31** Fixador Lâmina LS.32

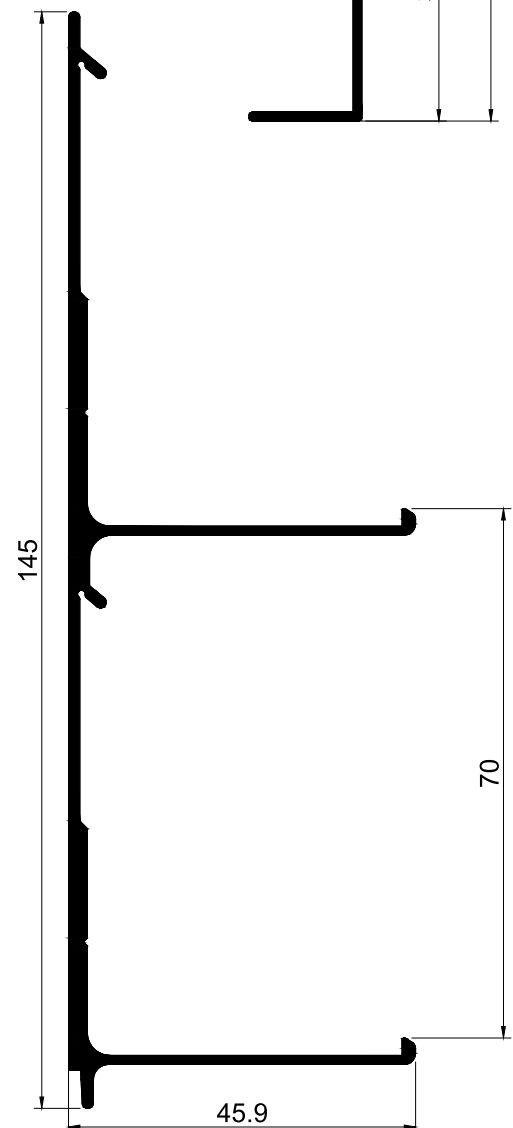

**LS.23** *Fixador Lâmina*

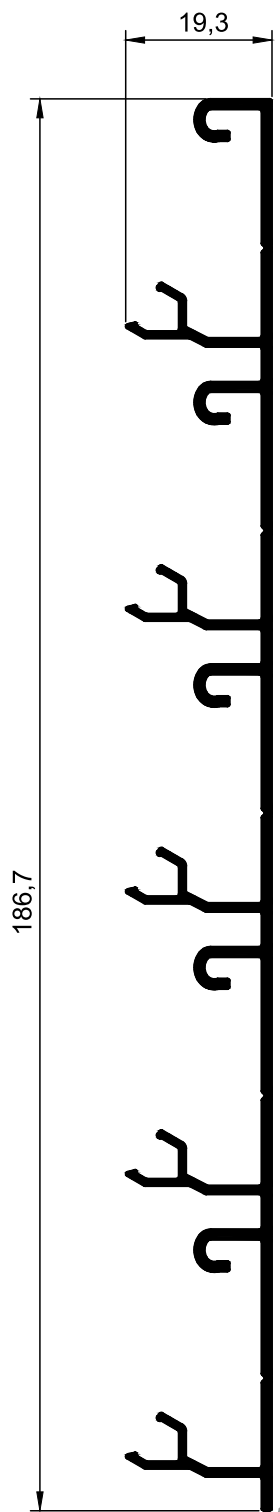

**LS.16** *Lâmina 26\*43mm*

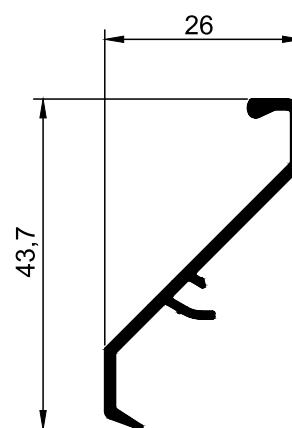

**LS.14** *Fixador Lâmina*

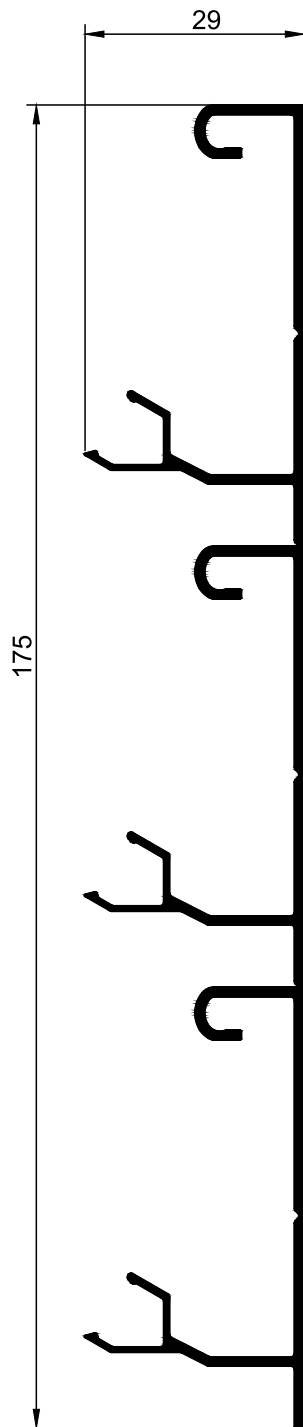

**LS.24** *Lâmina 51\*85mm*

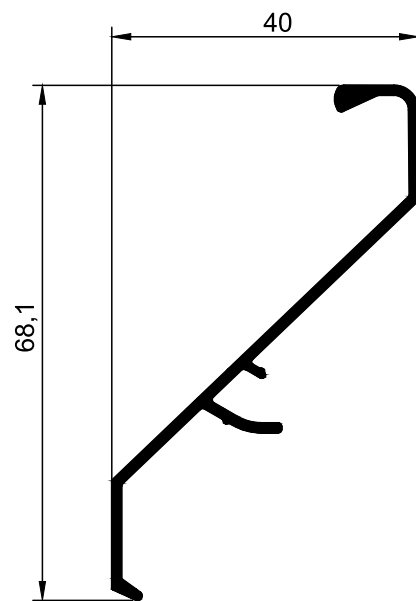

**LS.15** *Fixador Lâmina*

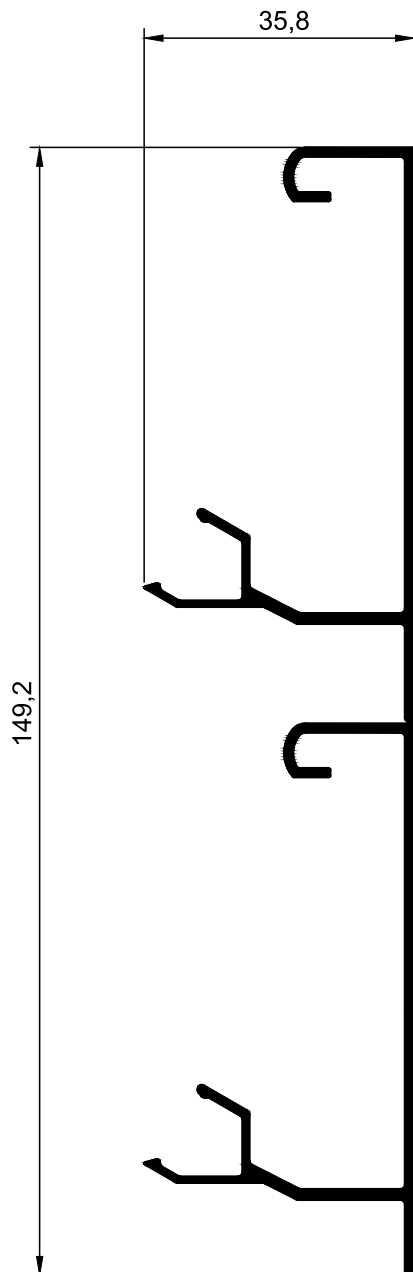

**LS.25** *Lâmina 51\*85mm*

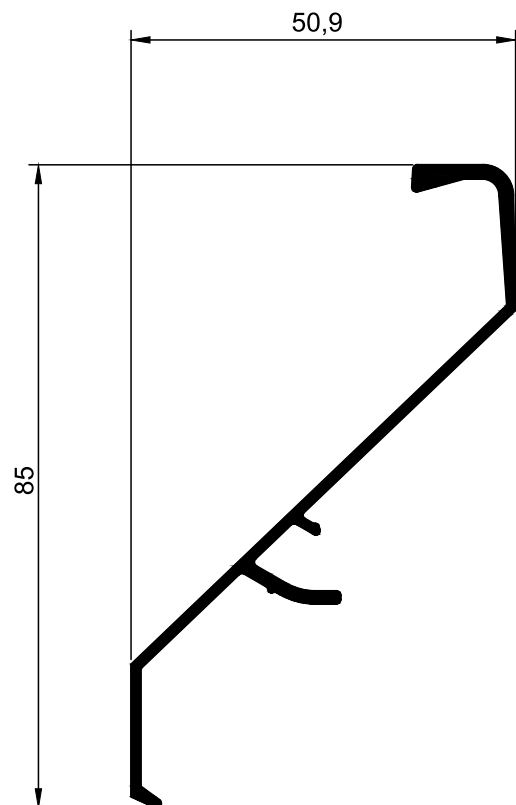



**LS.22** Aro Fixo P/LS.21,31,32

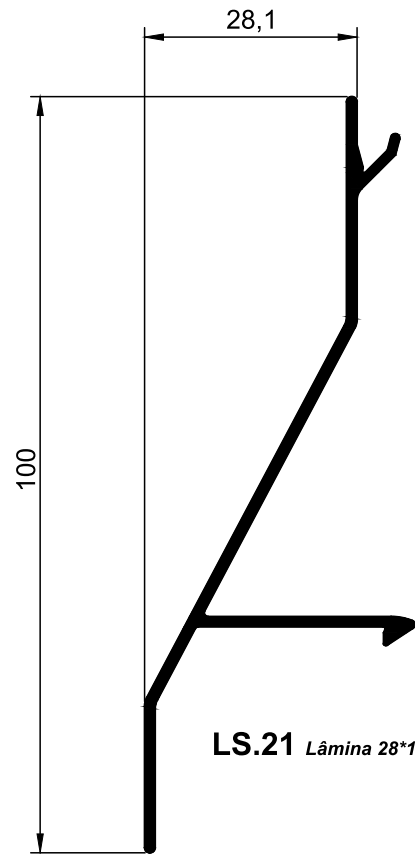
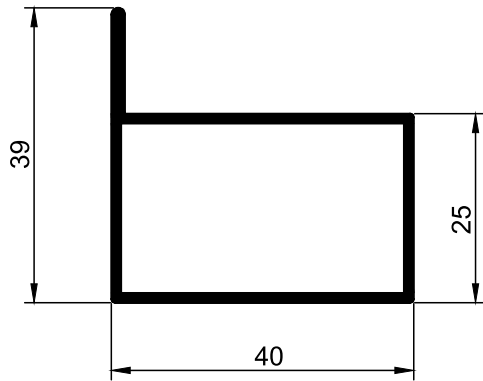

**LS.21** Lâmina 28\*100mm

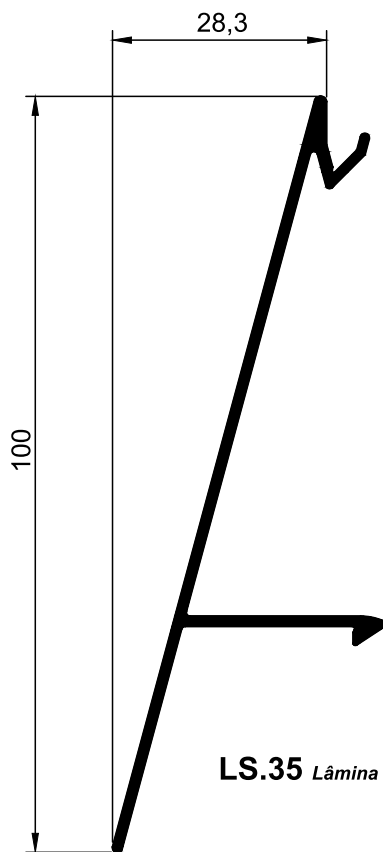

**LS.35** Lâmina 28\*100mm

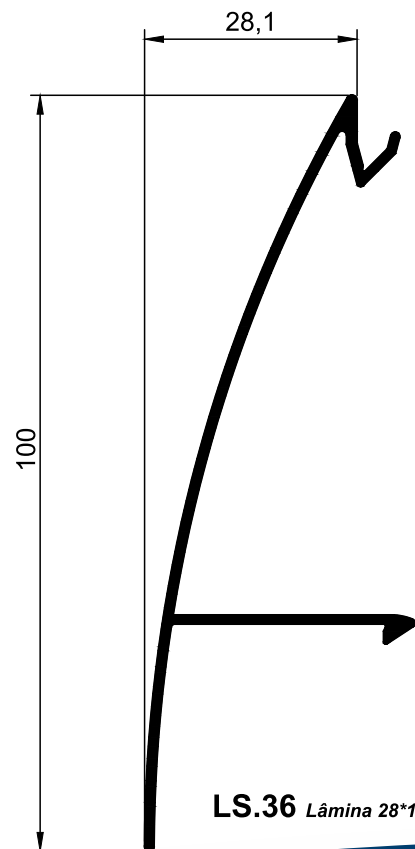

**LS.36** Lâmina 28\*100mm

# SÉRIE STANDARD

**ST.64** Régua Taipal

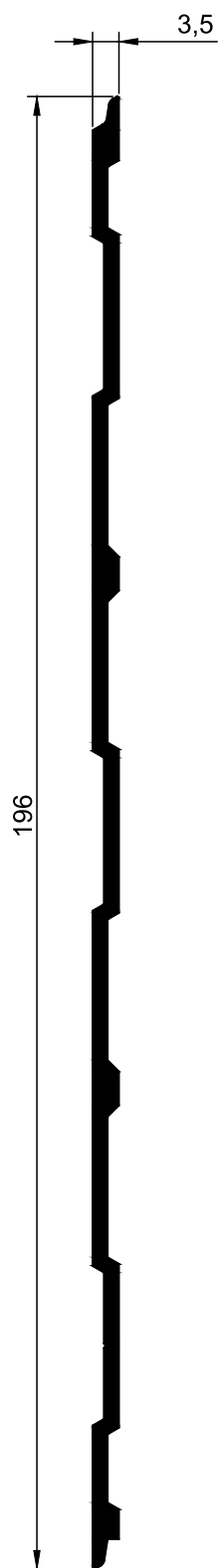

**ST.33** Régua Superior Taipal

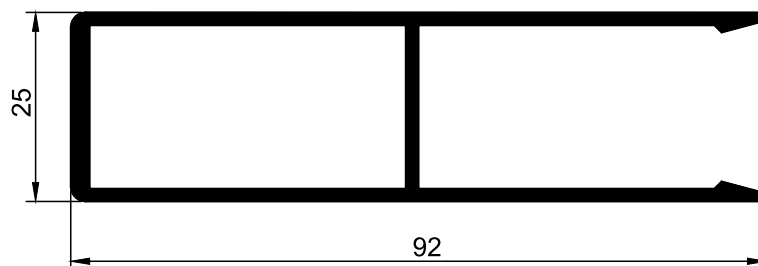

**ST.35** Régua Taipal

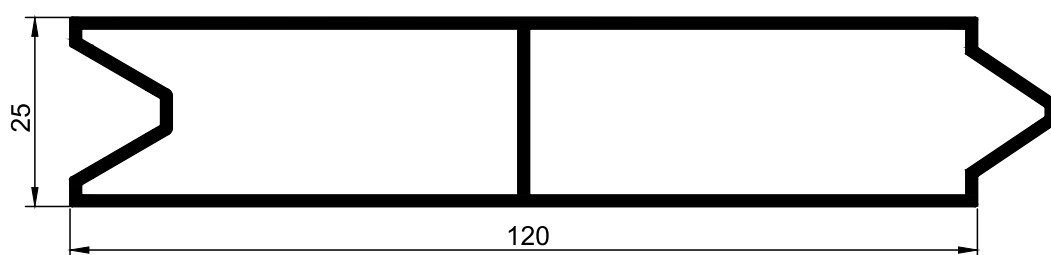

**ST.31** Régua Taipal

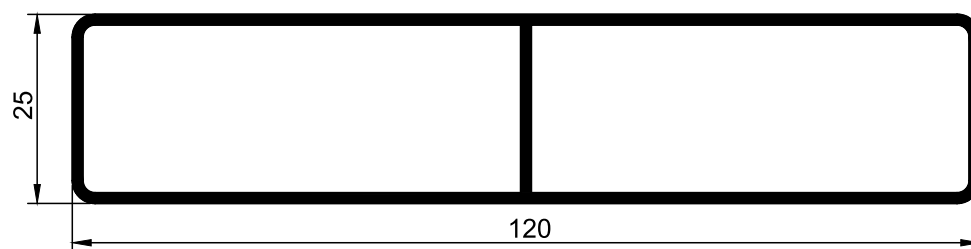

**ST.32** Régua Taipal

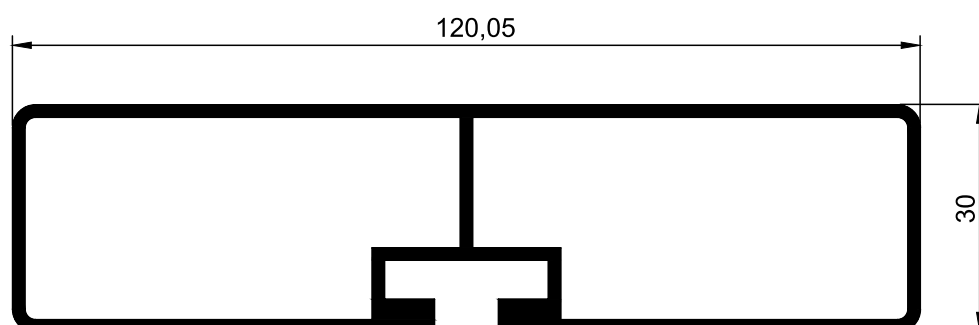

**ST.53** Peça Ligação Taipal

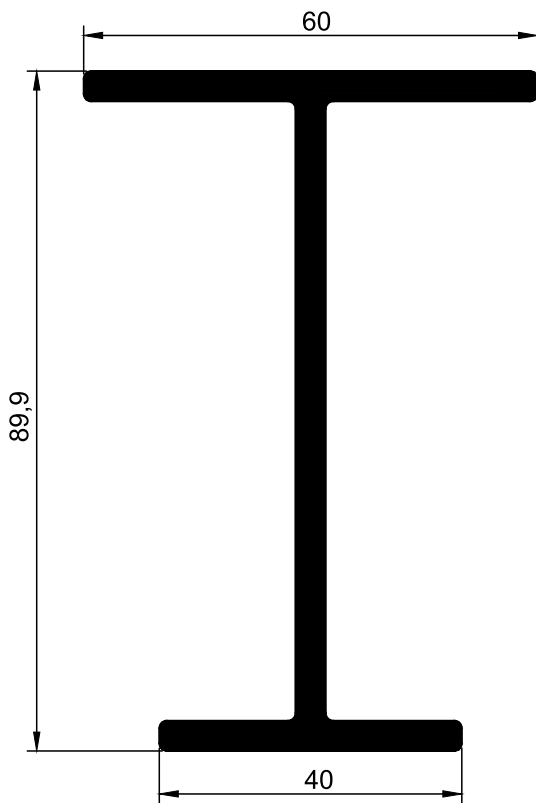

**ST.54** Peça Ligação Taipal

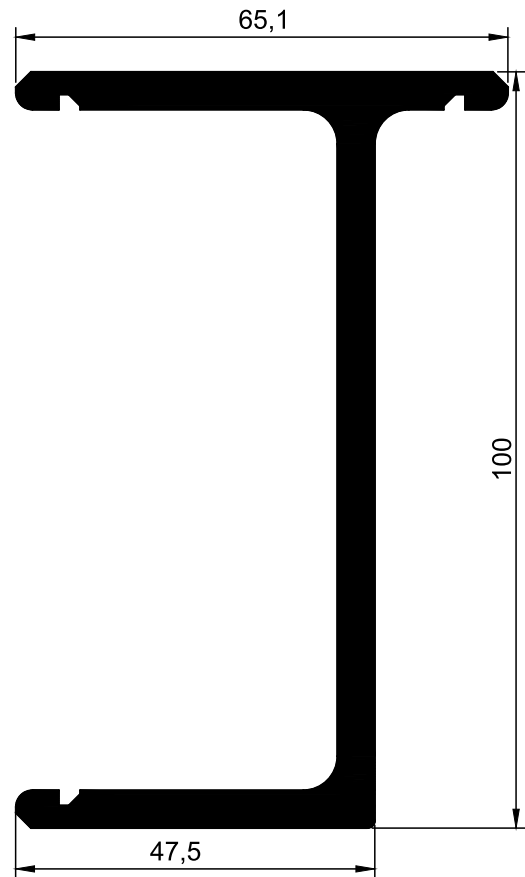

**ST.41** Peça Ligação Taipal

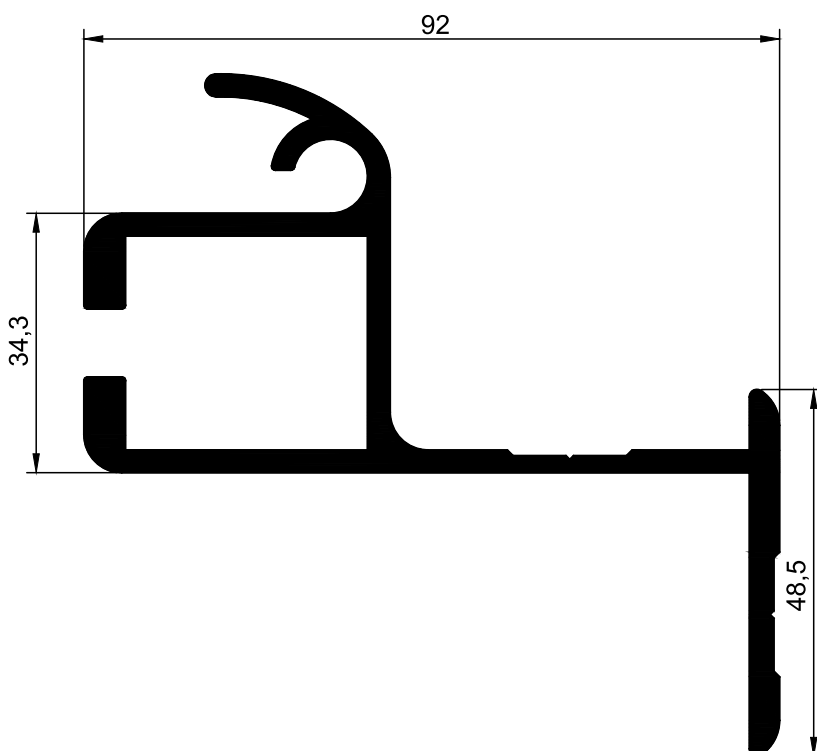

**ST.55** Peça Ligação Taipal

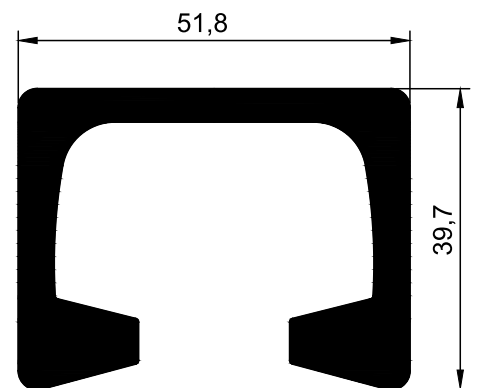

# SÉRIE STANDARD

**ES.18** *Calha Lateral*

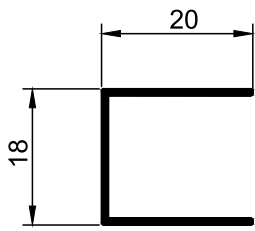

**ES.19** *Calha Lateral*

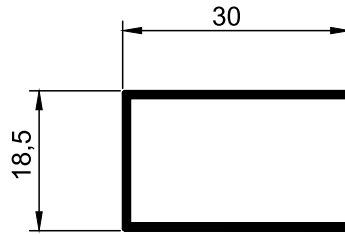

**ES.26** *Calha Lateral*

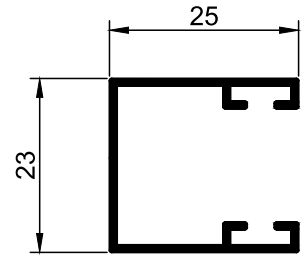

**ES.27** *Calha Lateral*

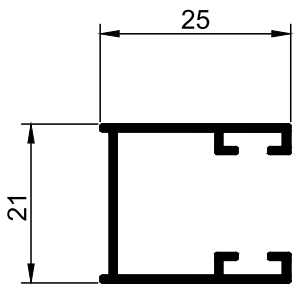

**ES.12** *Calha Lateral*

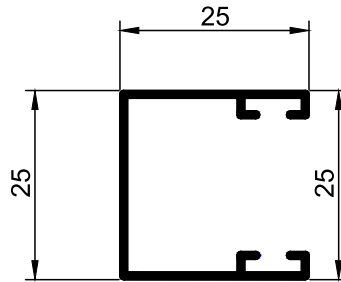

**ES.31** *Calha Lateral*

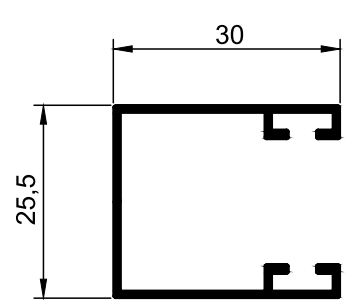

**ES.32** *Calha Lateral*

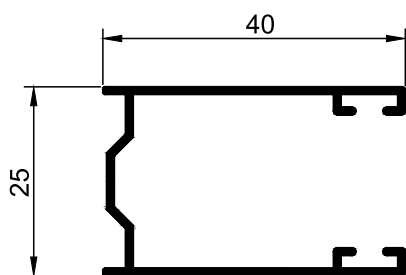

**ES.07** *Calha Lateral*

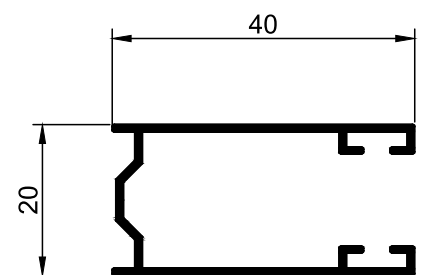

**ES.24** Calha Lateral

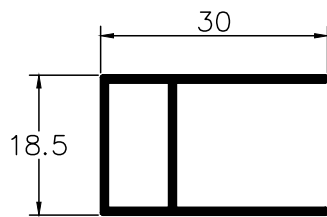

**ES.11** Calha Lateral

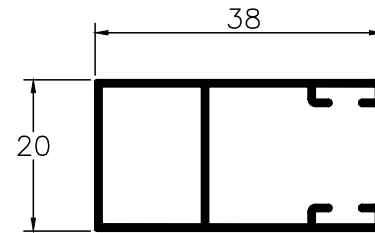

**ES.25** Calha Lateral

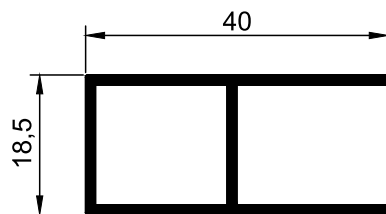

**ES.33** Calha Lateral

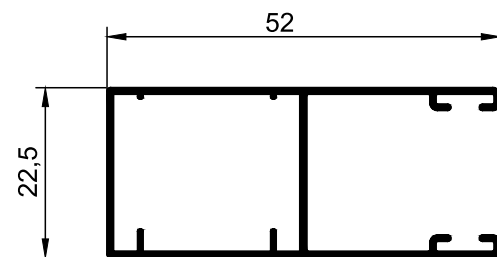

**ES.14** Calha Lateral

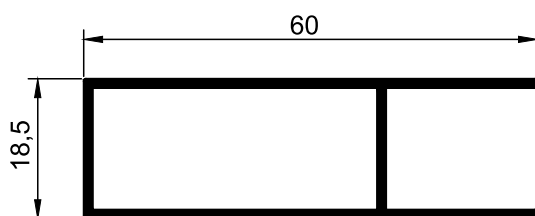

**ES.34** Calha Lateral

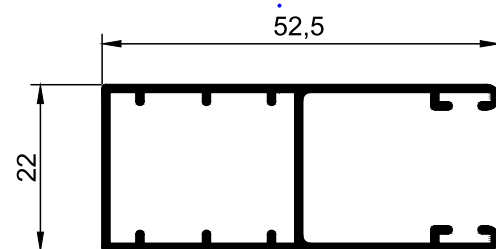

**ES.15** Calha Lateral

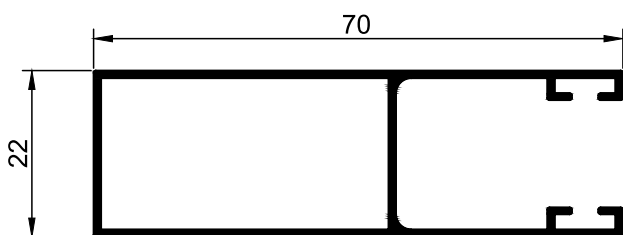

**ES.35** Calha Lateral

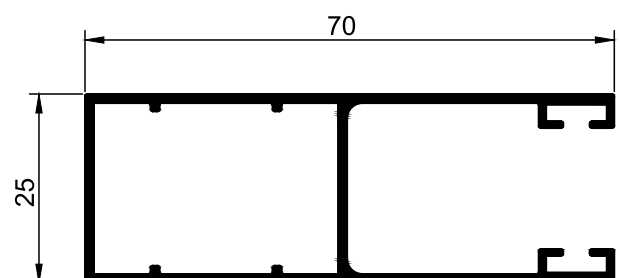

# SÉRIE STANDARD

**ES.20** Calha Lateral

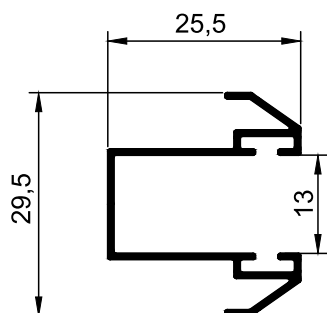

**ES.36** Calha Lateral

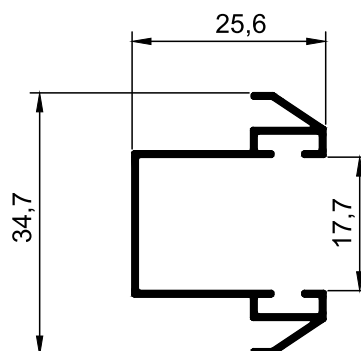

**ES.13** Calha Lateral

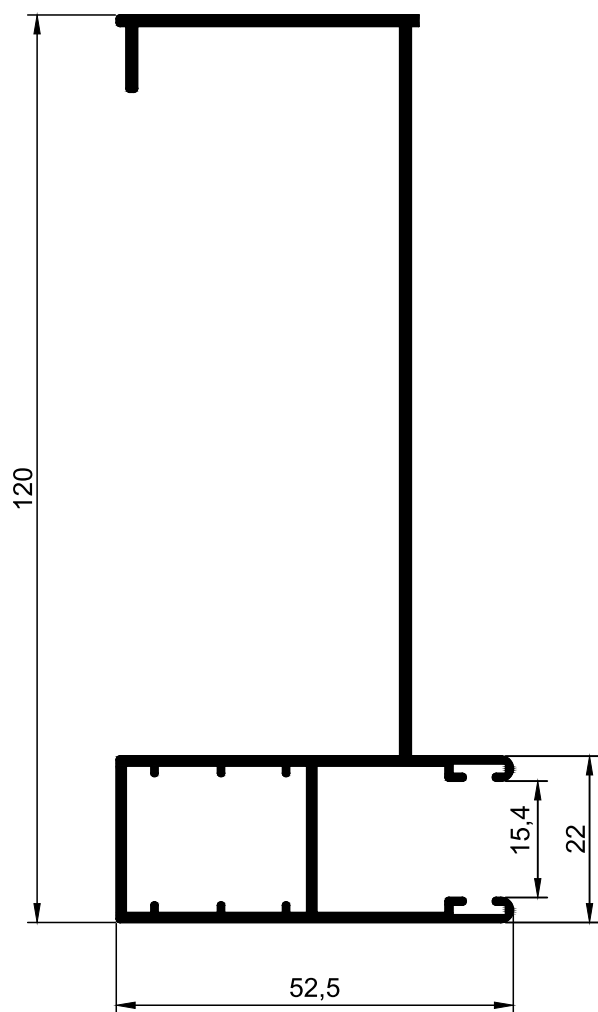

**ES.29** Calha Lateral

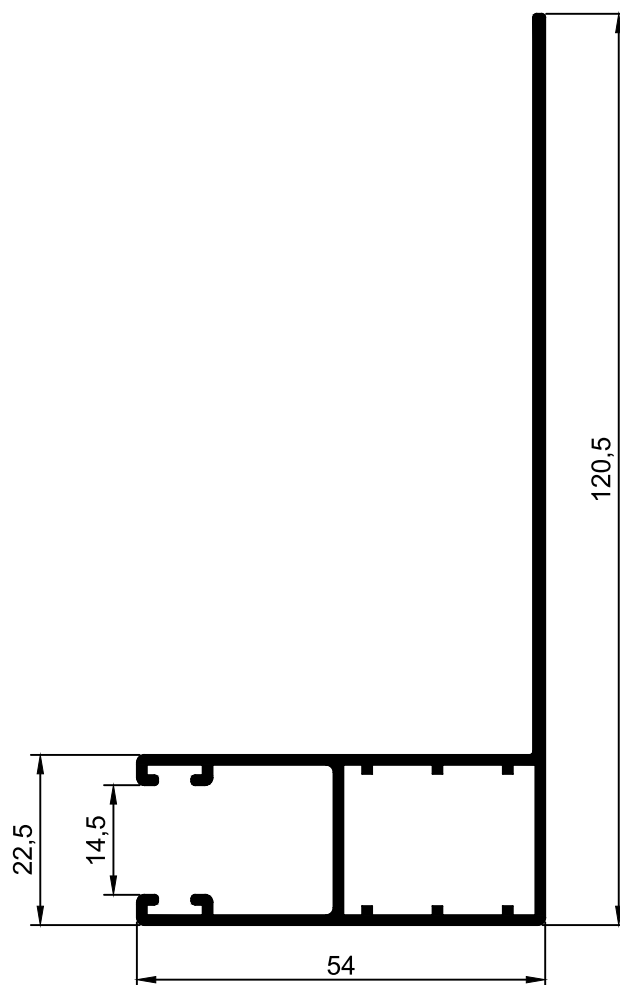

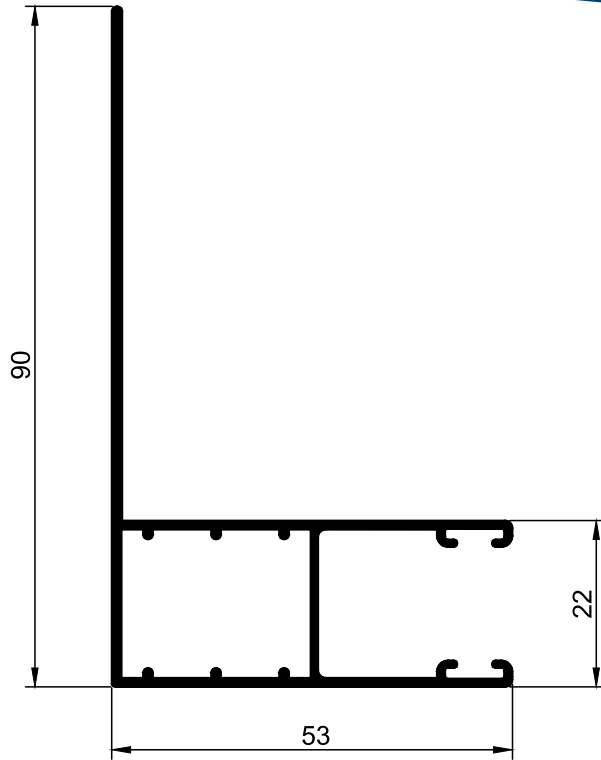

**ES.38** *Calha Lateral*

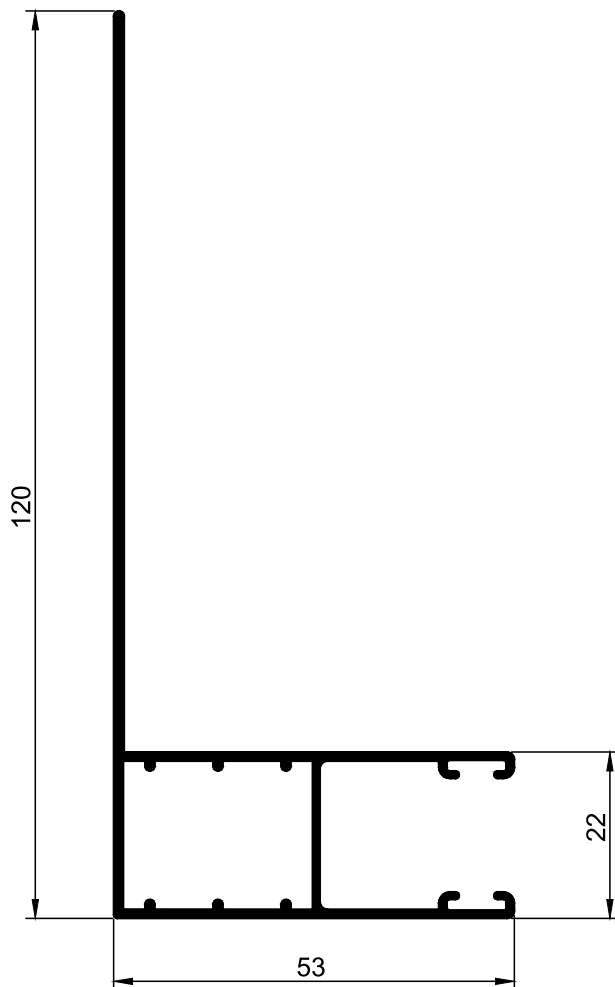

**ES.37** *Calha Lateral*

# SÉRIE STANDARD

**ES.39** *Tube Estore*

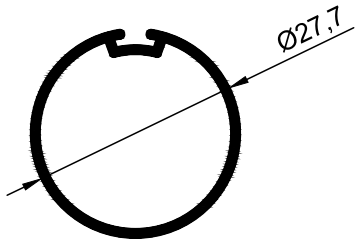

**ES.40** *Tube Estore*

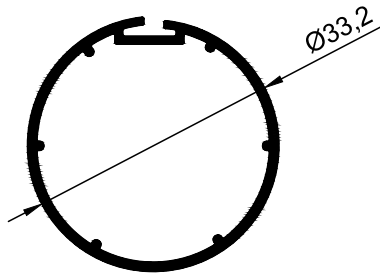

**ES.41** *Tube Estore*

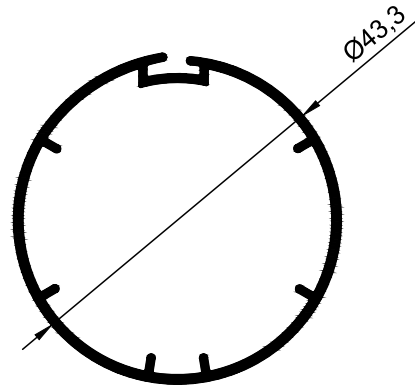

**ES.44** *Tube Estore*

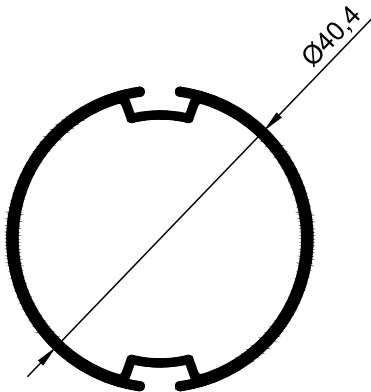

**ES.45** *Tube Estore*

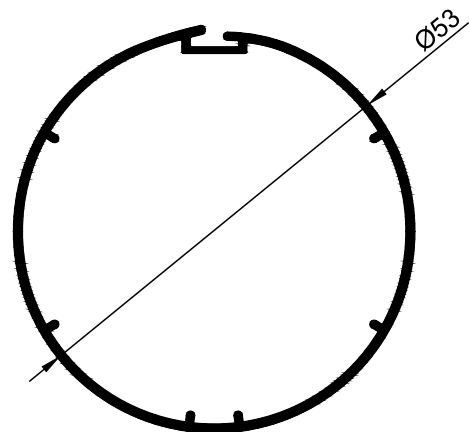



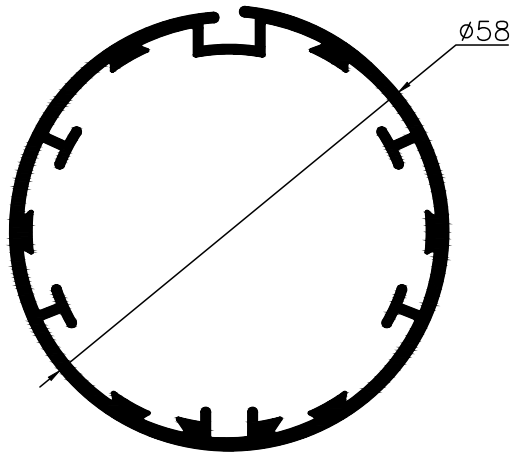

ES.46 *Tubo Estore*

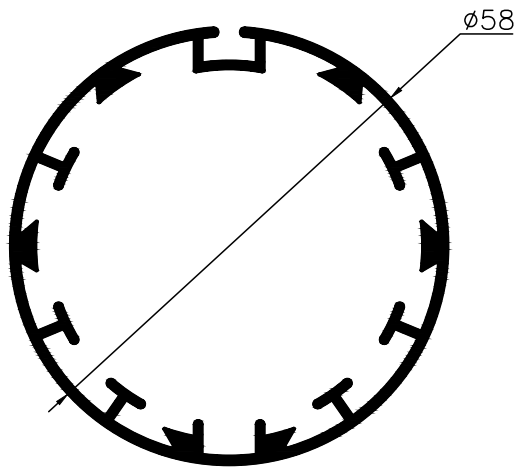

ES.47 *Tubo Estore*

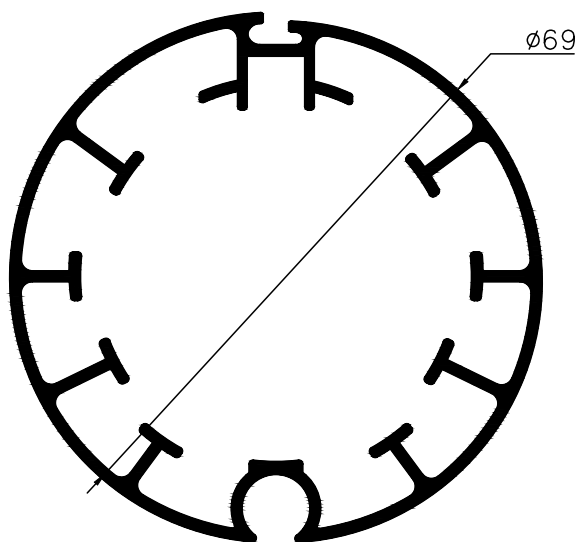

ES.48 *Tubo Estore*

# SÉRIE STANDARD

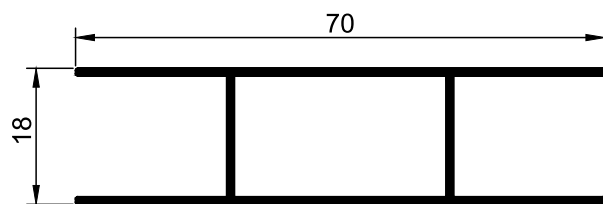

**ES.17** *Calha Central*

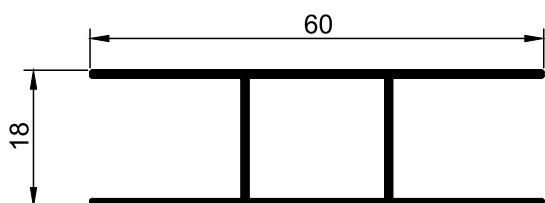

**ES.21** *Calha Central*

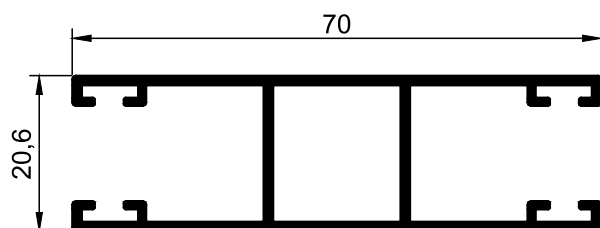

**ES.22** *Calha Central*

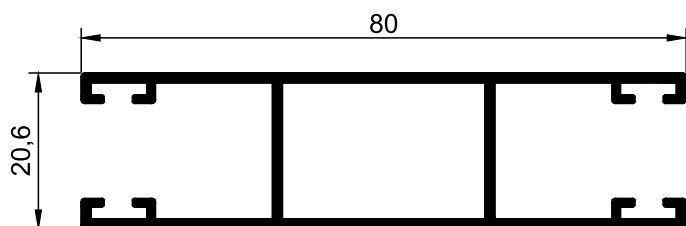

**ES.16** *Calha Central*

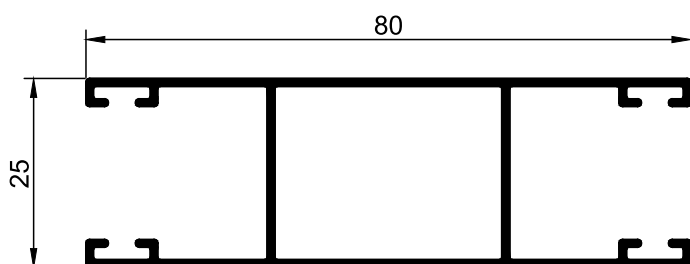

**ES.23** *Calha Central*

**ES.01** Lâmina

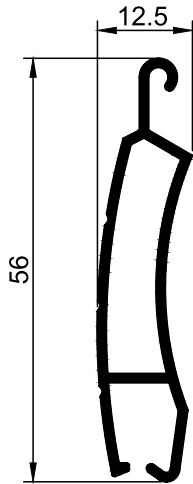

**ES.03** Terminal Lâmina

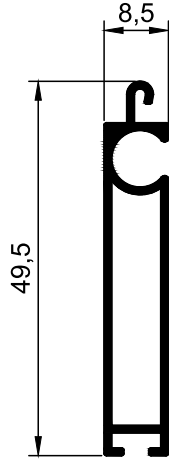

**ES.49** Terminal Lâmina

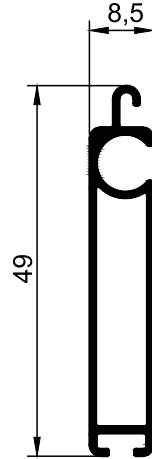

**ES.02** Lâmina

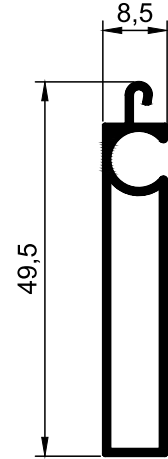

**ES.05** Lâmina

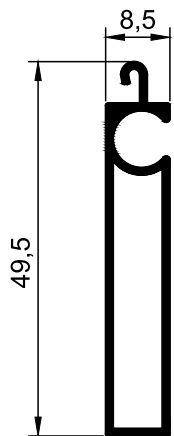

**ES.50** Terminal Lâmina

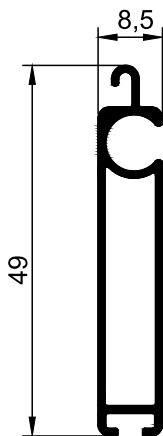

**ES.04** Lâmina

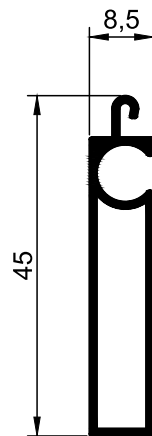

**ES.06** Terminal Lâmina

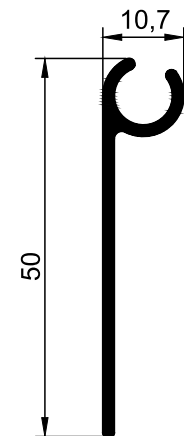

**ES.51** Lâmina

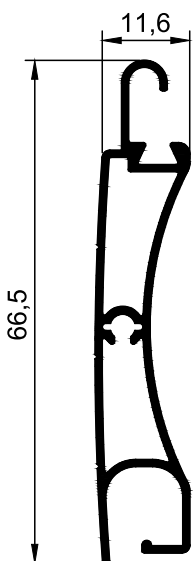

**ES.52** Terminal Lâmina

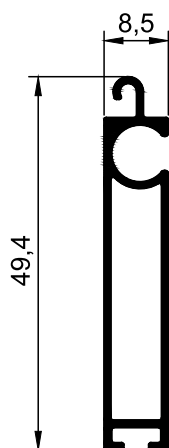

**ES.53** Terminal Lâmina

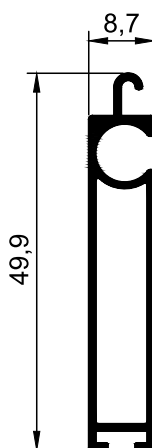

**ES.54** Terminal Lâmina

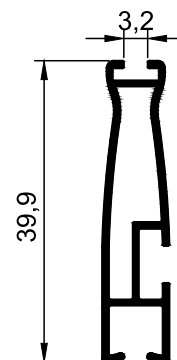

**ES.42** Terminal Lâmina

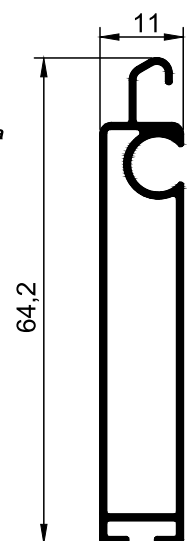

# SÉRIE STANDARD

**ES.55** Calha Lateral

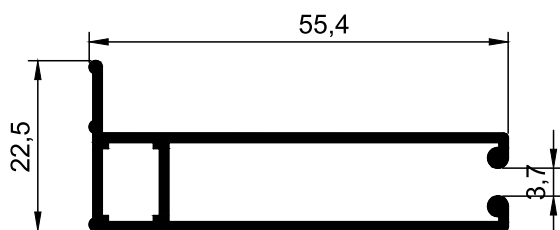

**ES.56** Calha Lateral

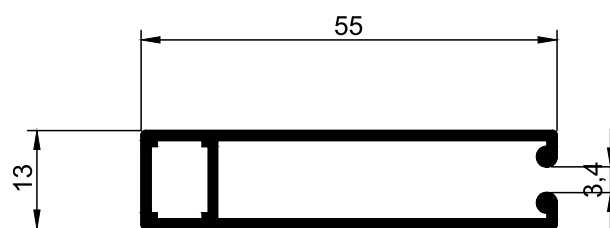

**ES.57** Terminal

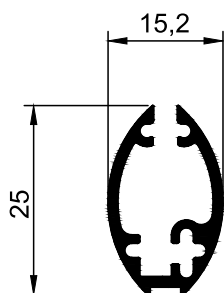

**ES.58** Terminal

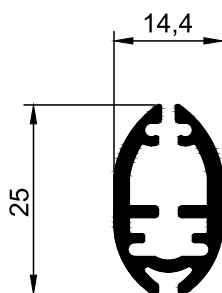

**ES.59** Terminal

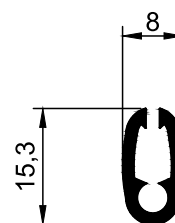

**ES.60** Terminal

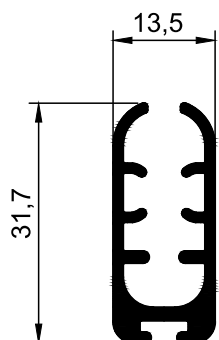

**ES.61** Terminal

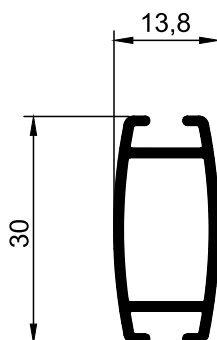

**ES.62** Base Redonda

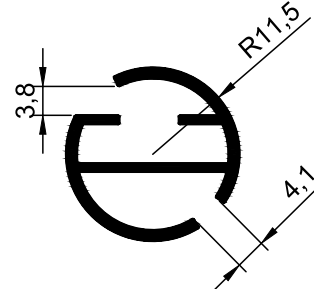

**ES.63** *Calha Estore*

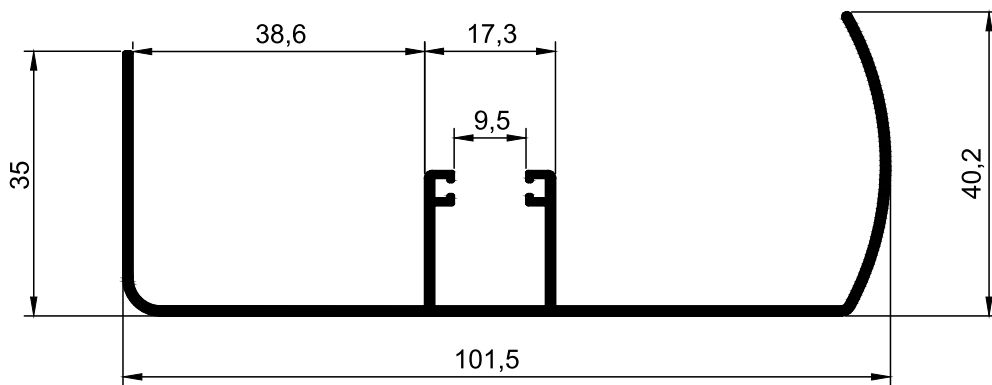

**ES.64** *Calha Estore*

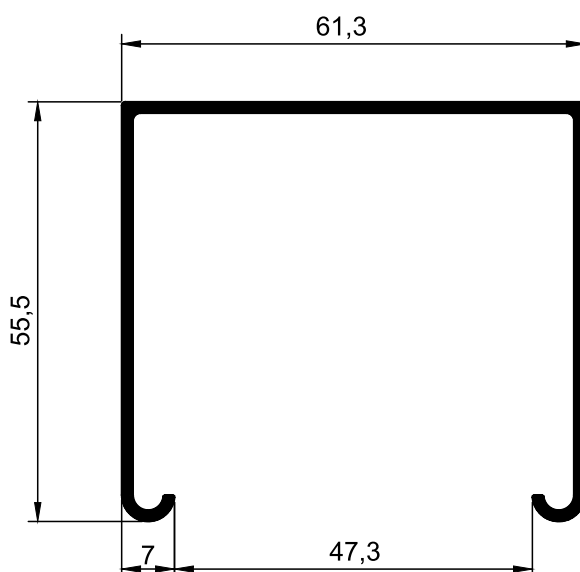
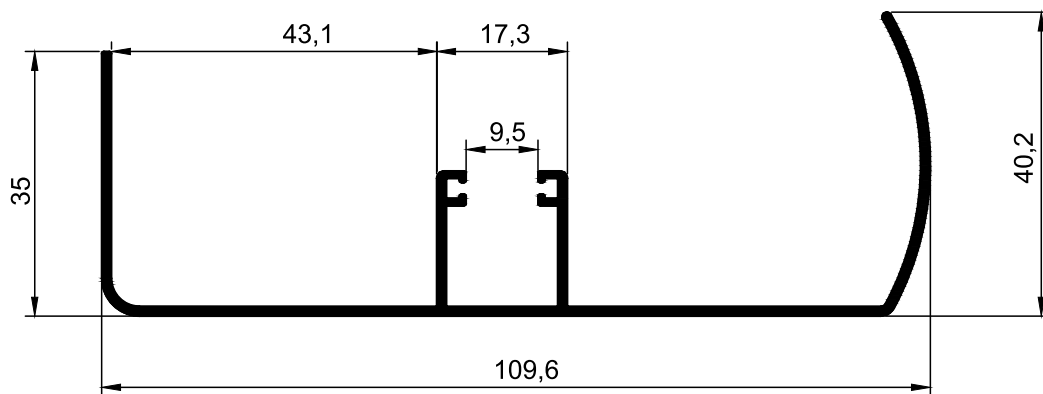

**ES.65** *Calha Estore*

# SÉRIE STANDARD

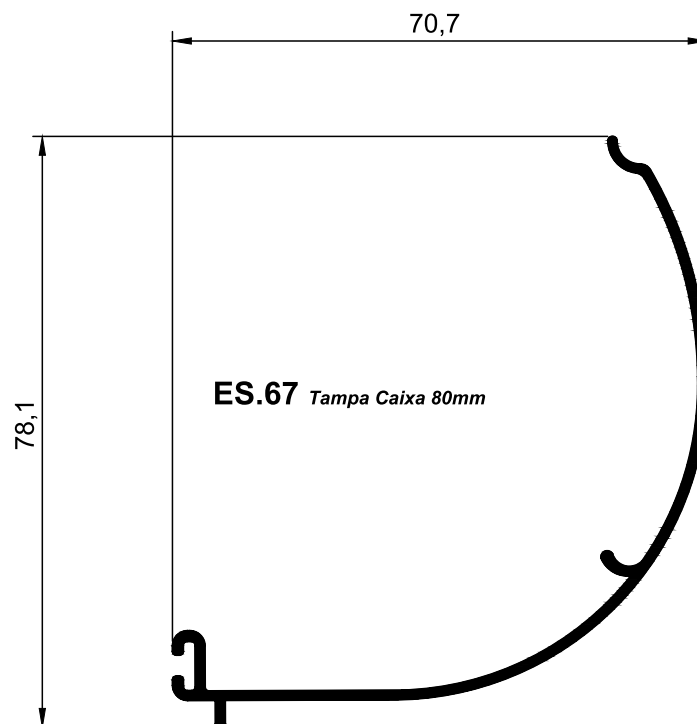
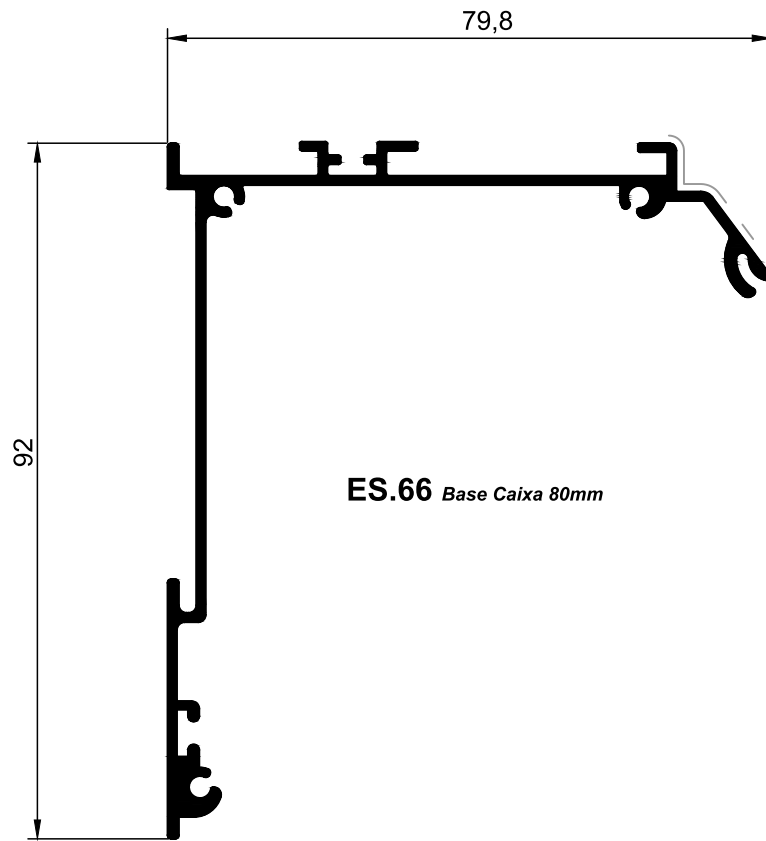

**ST.01** Peça Ligação

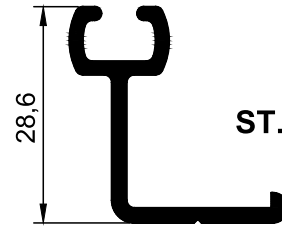
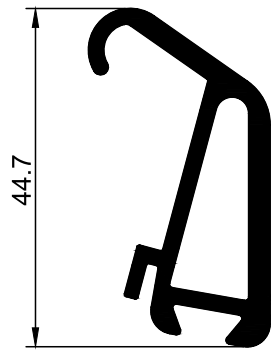
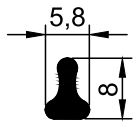

**ST.02** Peça Ligação

**ST.03** Peça Ligação

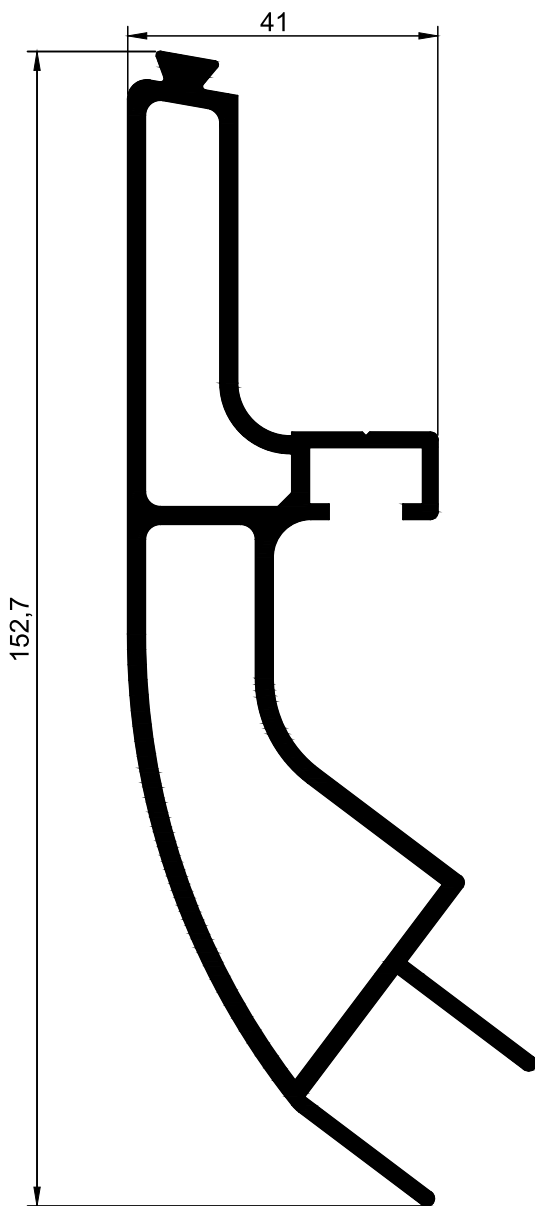

**ST.04** Perfil Moldura

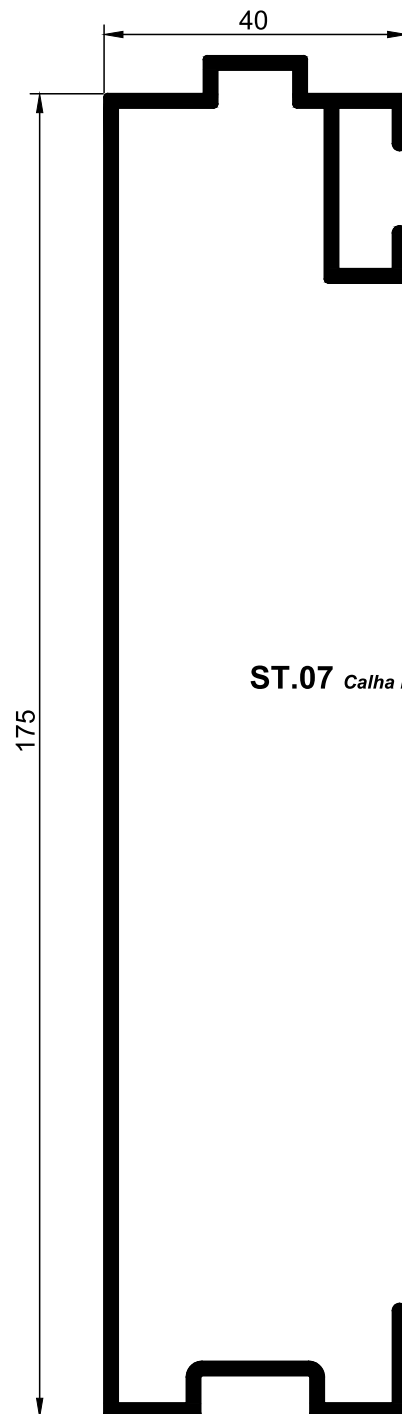

**ST.07** Calha Moldura

**ST.08** *Réguas Moldura*

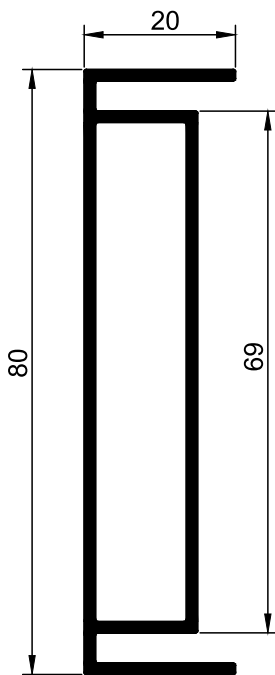

**ST.09** *Régua Moldura*

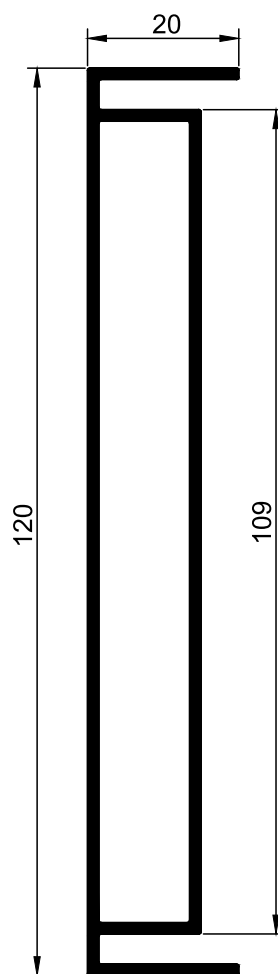



**ST.12** *Prateleira*

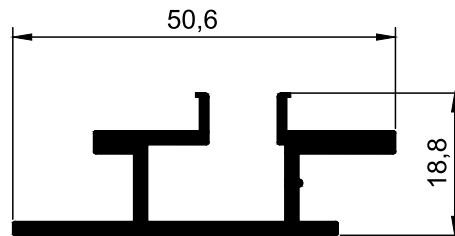

**ST.11** *Prateleira*

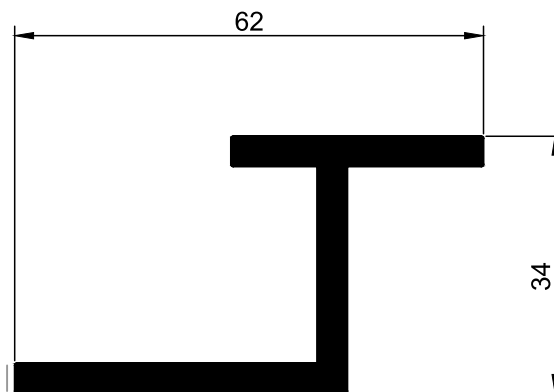

**ST.14** *Prateleira*

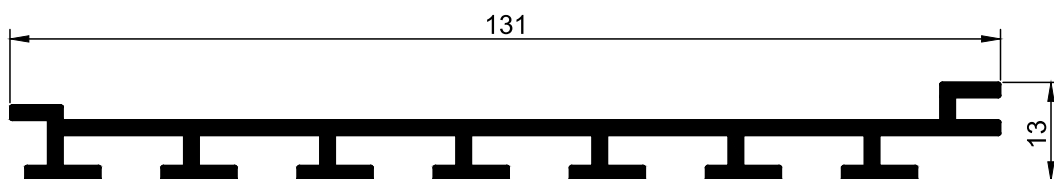

# SÉRIE STANDARD

**V.10** Vidrinhos

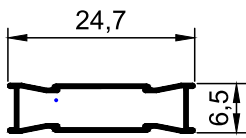

**V.12** Vidrinhos

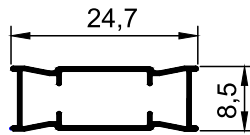

**V.02** Vidrinhos

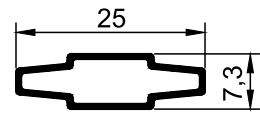

**V.03** Vidrinhos

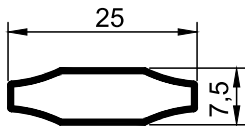

**V.01** Vidrinhos

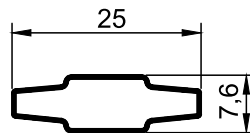

**V.04** Vidrinhos

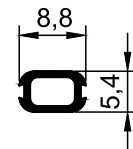

**V.09** Vidrinhos

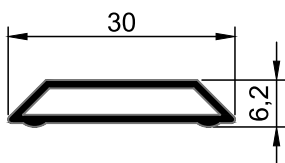

**V.08** Vidrinhos

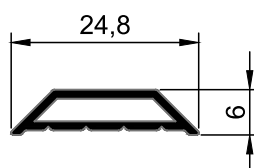

**V.07** Vidrinhos

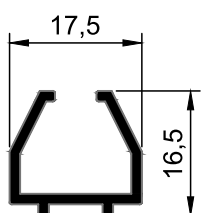
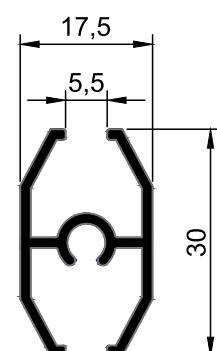

**V.06** Vidrinhos

**RM.03** Rede Mosquiteira Carril

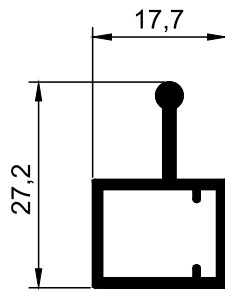

**RM.10** Rede Mosquiteira Puxador

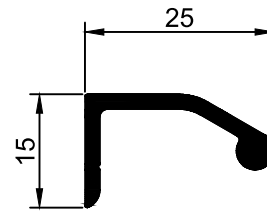

**RM.02** Rede Mosquiteira Aro Móvel

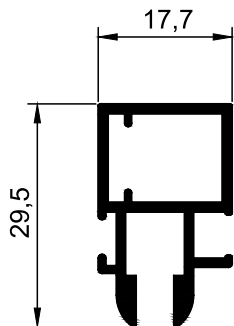

**RM.11** Rede Mosquiteira Aro Móvel

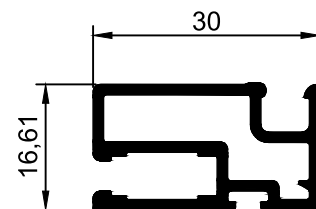

**RM.01** Rede Mosquiteira Travessa

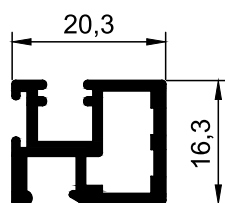

**RM.12** Rede Mosquiteira Travessa

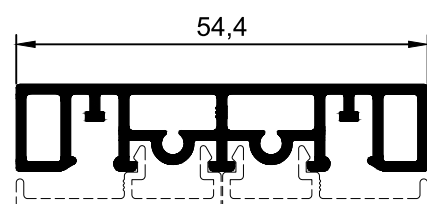

**RM.04** Rede Mosquiteira

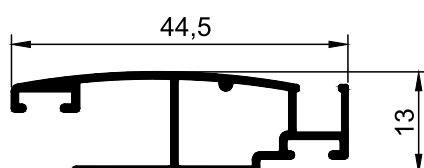

**RM.13** Rede Mosquiteira Remate

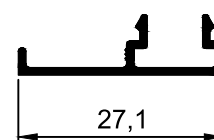

# SÉRIE STANDARD

**BC.02** Perfil Mobiliário 90°  
Redondo

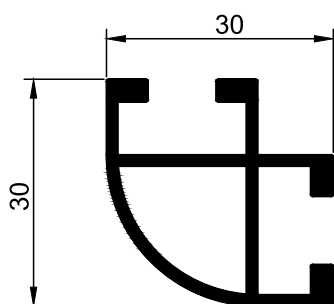

**BC.01** Perfil Mobiliário 90°  
Recto

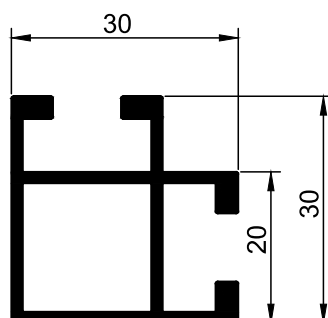

**BC.04** Perfil Mobiliário  
Travessa Dupla

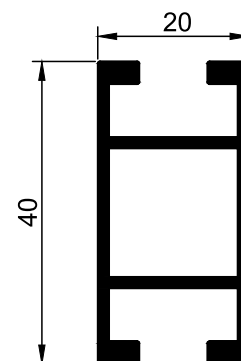

**BC.03** Perfil Mobiliário  
Travessa Dupla

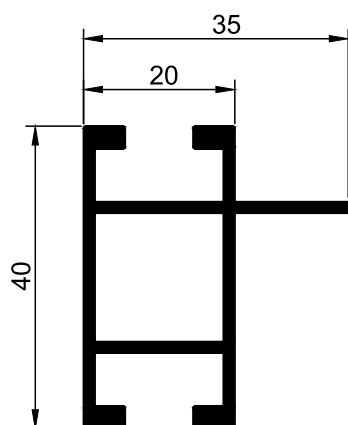

**BC.05** Perfil Mobiliário  
Travessa Tripla

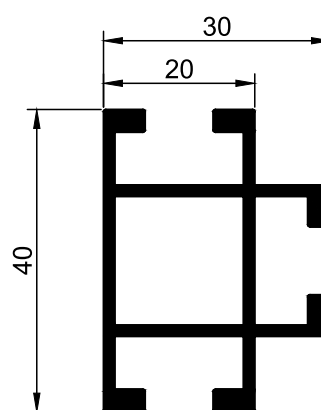

**BC.06** Perfil Mobiliário  
Travessa Tripla

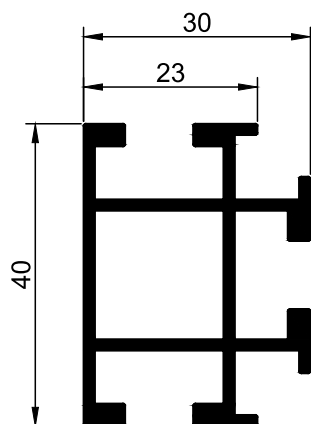

**BC.07** Perfil Mobiliário Estrela

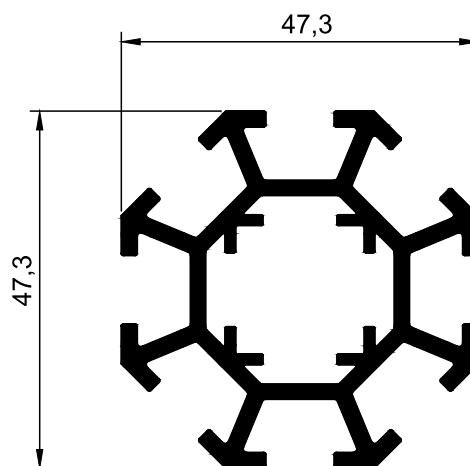

**ST.98** *Perfil Inferior*

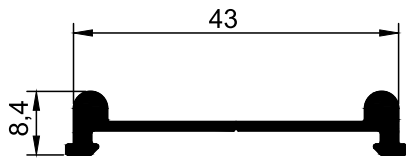

**ST.96** *Perfil Superior*

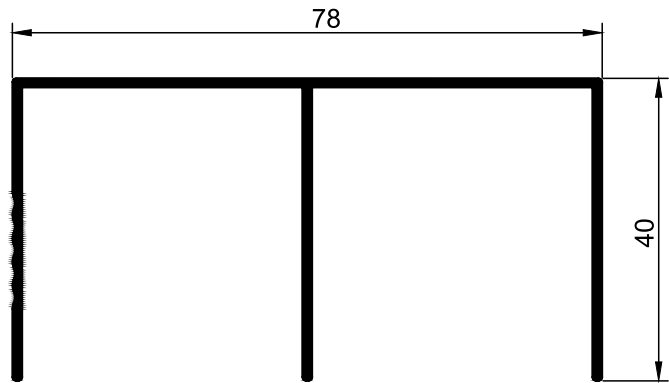

**ST.97** *Perfil Mòvel*

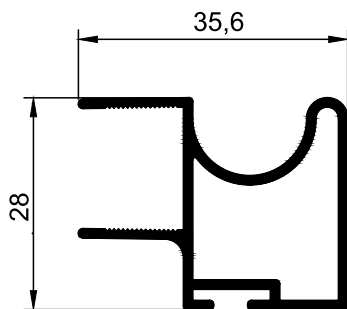

**ST.101** *Perfil Cabide Reforçado*

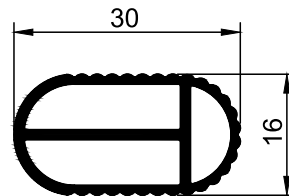

**ST.100** *Perfil Cabide*

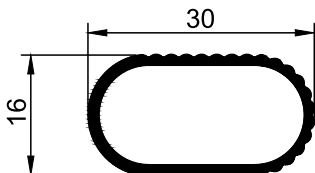

**ST.99** *Perfil Cabide*

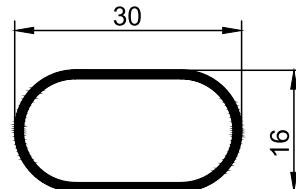

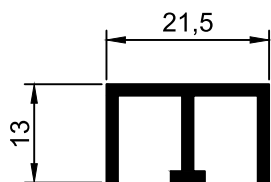

**VT.01** *Padeira*

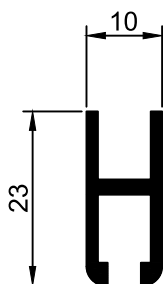

**VT.03** *Perfil Móvel*

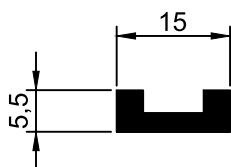

**VT.02** *Soleira*





**NORTALU<sup>®</sup>**

**ACESSÓRIOS**



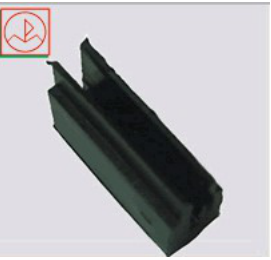
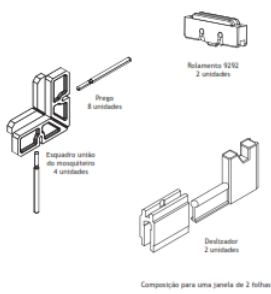
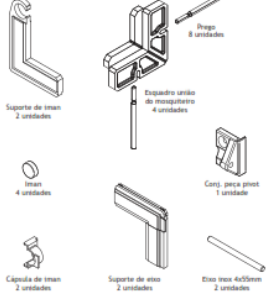
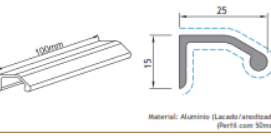





ARTIGO	DESCRIÇÃO	APLICAÇÃO
	<p><b>RM 533P</b></p> <p>Esquadro Rede Mosquiteira NYLON</p>	
	<p><b>RM 401P</b></p> <p>Deslizador Nylon Rede Mosquiteira</p>	
	<p><b>223247</b></p> <p>KIT Mosquiteira de Correr</p>	
	<p><b>223250</b></p> <p>KIT Mosquiteira de Batente</p>	
	<p><b>200631</b></p> <p>KIT Puxador Rede Mosquiteira</p>	
	<p><b>RM 101C</b></p> <p>Rede Mosquiteira 1,20 Largura</p>	

ARTIGO	DESCRIÇÃO	APLICAÇÃO
	<b>RM 12080</b> Vedante Rede Mosquiteira	
	<b>L10451</b> Ligação Travessa Mobiliário	
	<b>L10452</b> Ligação Travessa Mobiliário	
	<b>L40401</b> União Cantos Móveis	
	<b>L40403</b> Tampa União Cantos Móveis	
	<b>L40411</b> Pé Regulável Móveis	
	<b>L40412</b> Suporte Vidro	

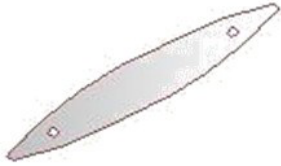

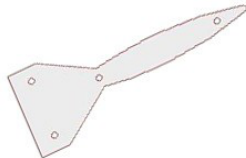
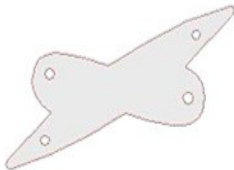
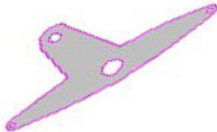
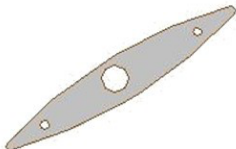
ARTIGO	DESCRIÇÃO	APLICAÇÃO
	<b>L40413</b> Dobradiça	
	<b>L40414</b> Fecho Íman	
	<b>DI D6001</b> Agarras C/Parafuso P/Divisória	
	<b>DI D6005</b> Molas Para Divisória	
	<b>VD 05390</b> Vedante P/Serie DI	
	<b>VT RODIZIO</b> Rodizio P/Vitrina	
	<b>VT CALHA</b> Calha P/Vitrina	

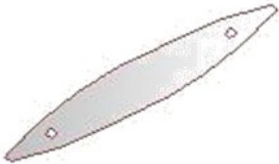

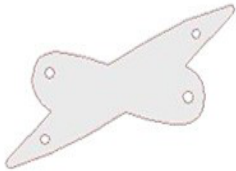
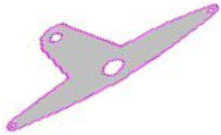
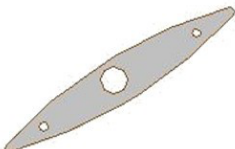
# SÉRIE STANDARD

ARTIGO	DESCRIÇÃO	APLICAÇÃO
	<b>L10605</b> Topo Lâmina 120mm	
	<b>L10610</b> Suporte Avançado Lâmina 120mm	
	<b>L10615</b> Suporte Concha Lâmina 120mm	
	<b>L10650</b> Topo Fixação Lateral Lâmina 120mm	
	<b>L10655</b> Topo Fixação C/ Orelhas Lâmina 120mm	
	<b>L10660</b> Topo Móvel Lâmina 120mm	
	<b>L10675</b> Topo Móvel Lâmina 120mm	

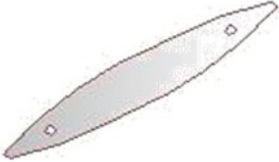

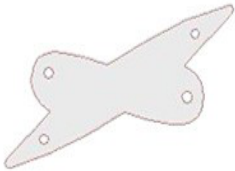
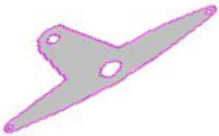
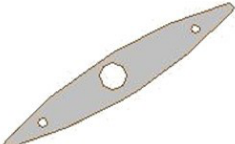

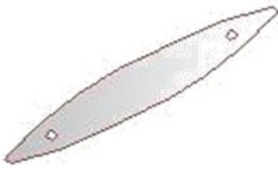
ARTIGO	DESCRIÇÃO	APLICAÇÃO
	<b>L10690</b> Topo Lâmina 150mm	
	<b>L10695</b> Suporte Avançado Lâmina 150mm	
	<b>L10700</b> Suporte Concha Lâmina 150mm	
	<b>L10745</b> Topo Fixação C/ Orelhas Lâmina 150mm	
	<b>L10705</b> Topo Móvel Lâmina 150mm	
	<b>L10710</b> Topo Móvel Lâmina 150mm	

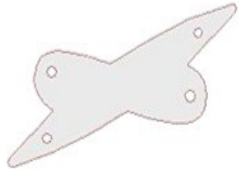
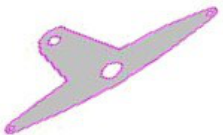
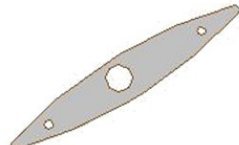
# SÉRIE STANDARD



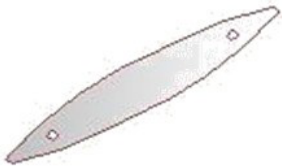

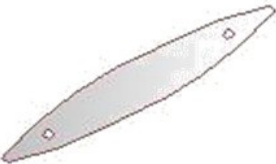

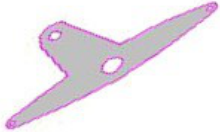
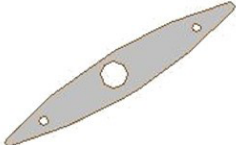
ARTIGO	DESCRIÇÃO	APLICAÇÃO
	<b>L10620</b> Topo Lâmina 170mm	
	<b>L10625</b> Suporte Avançado Lâmina 170mm	
	<b>L10630</b> Suporte Concha Lâmina 170mm	
	<b>L10760</b> Topo Fixação C/ Orelhas Lâmina 170mm	
	<b>L10665</b> Topo Móvel Lâmina 170mm	
	<b>L10680</b> Topo Móvel Lâmina 170mm	

ARTIGO	DESCRIÇÃO	APLICAÇÃO
	<b>L10635</b> Topo Lâmina 200mm	
	<b>L10640</b> Suporte Avançado Lâmina 200mm	
	<b>L10645</b> Suporte Concha Lâmina 200mm	
	<b>L10740</b> Topo Fixação C/ Orelhas Lâmina 200mm	
	<b>L10670</b> Topo Móvel Lâmina 200mm	
	<b>L10685</b> Topo Móvel Lâmina 200mm	

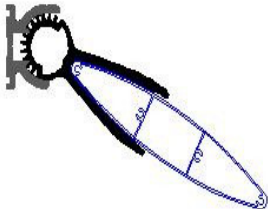
# SÉRIE STANDARD

ARTIGO	DESCRIÇÃO	APLICAÇÃO
	<b>L10750</b> Topo Lâmina 350mm	
	<b>L10755</b> Suporte Concha Lâmina 350mm	
	<b>L10715</b> Topo Lâmina 400mm	
	<b>L10720</b> Suporte Avançado Lâmina 400mm	
	<b>L10725</b> Suporte Concha Lâmina 400mm	
	<b>L10730</b> Topo Móvel Lâmina 400mm	
	<b>L10735</b> Topo Móvel Lâmina 400mm	



ARTIGO	DESCRIÇÃO	APLICAÇÃO
	<b>L10792</b> Fixador à Lâmina 120 a 150mm	
	<b>L10794</b> Fixador à Lâmina 170 a 200mm	
	<b>L20651</b> Tampa Perfil Lâmina	
	<b>L40321</b> Kit Acessórios Lâminas Móveis 120mm	
	<b>L40322</b> Kit Acessórios Lâminas Móveis 170mm	
	<b>L40323</b> Kit Acessórios Lâminas Móveis 170mm	
	<b>L40326</b> Kit Acessórios Lâminas Móveis 350/400mm	

# SÉRIE STANDARD

ARTIGO	DESCRIÇÃO	APLICAÇÃO
	<b>L40324</b> Ligação Motor/Kitline	
	<b>L40324</b> Ligação Motor/Kitline	
	<b>L40306</b> Motor Motorline 180mm MCB18 - 600N	
	<b>L40307</b> Motor Motorline 230mm MCB23 - 600N	
	<b>L40310</b> Comando Monocanal + Central	
	<b>L40312</b> Conjunto KitLine	
	<b>Kit LM LS33</b> Kit Acessórios Lâminas Móveis LS33	





**NORTALU<sup>®</sup>**

📍 Rua Dr. José Bragança Tavares, 78 Fr. A  
4580-593 Paredes(Mouriz)

☎ 255 781 548/49

☎ 92 705 80 65

✉ [nortalu@nortalu.com](mailto:nortalu@nortalu.com)



**[www.nortalu.pt](http://www.nortalu.pt)**



**[www.nortalu.com](http://www.nortalu.com)**



**[www.nortalu.fr](http://www.nortalu.fr)**